

Installation- and Operation Instructions

AIRWIN®
Ultrasonic Duct Humidifier

NKBD-6...42/3.1

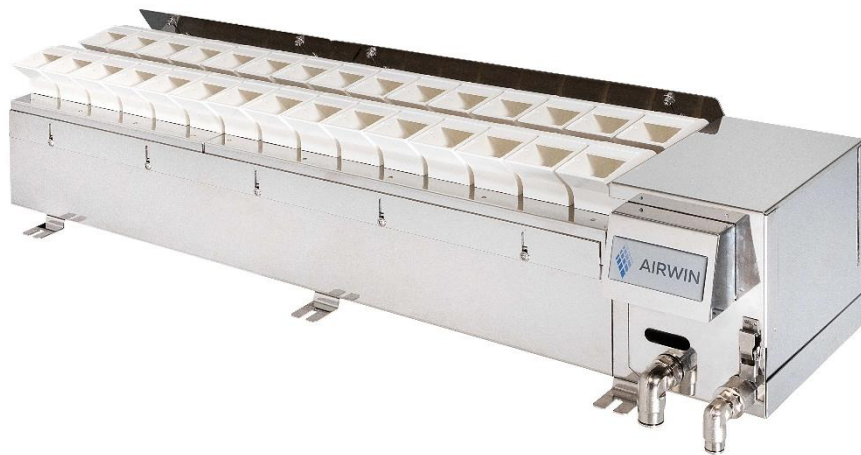

Type	Item No.	Description	max. capacity
NKBD-6/3.1	7900107	Duct humidifier with 6 outlets	3.6 kg/h
NKBD-12/3.1	7900113	Duct humidifier with 12 outlets	7.2 kg/h
NKBD-18/3.1	7900119	Duct humidifier with 18 outlets	10.8 kg/h
NKBD-24/3.1	7900125	Duct humidifier with 24 outlets	14.4 kg/h
NKBD-30/3.1	7900131	Duct humidifier with 30 outlets	18.0 kg/h
NKBD-36/3.1	7900137	Duct humidifier with 36 outlets	21.6 kg/h
NKBD-42/3.1	7900143	Duct humidifier with 42 outlets	25.2 kg/h

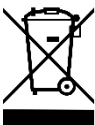

Please read and keep these instructions!

Contents

1.	General Informations and Intended Use.....	4
2.	Safety Instructions	4
3.	Scope of delivery	5
4.	Optional accessories	5
5.	General information	7
5.1	Technical terms	7
5.2	Physical principles of piezo ceramics.....	7
5.3	Funktionsbeschreibung Ultraschall-Luftbefeuchter	8
6.	Advantages of ultrasonic air humidification	9
7.	Equipment overview	10
8.	The NKBD-6...42/3.1-System	11
9.	Installation.....	12
9.1	Installation conditions – General notes	12
9.2	Installation conditions – special notes.....	13
9.2.1	Standard configuration.....	13
9.2.2	Stepped configuration	14
9.3	Suction operation	15
9.4	Recommended settings of the airflow	16
9.4.1	Folded sheet and extension on the body duct support.....	16
9.4.2	Closing sheet on the tank cover	16
9.5	Adjustment of the NKBD to the direction of airflow	17
10.	Hydraulic connection	18
10.1	Hydraulic conditions	18
10.2	Establishing and detaching the connections with connectors.....	19
11.	Electrical Connection.....	20
11.1	Transformer.....	20
11.2	Humidifier	21
11.2.1	Power connection	21
11.2.2	Control connection.....	21
11.2.3	Modbus RTU-Interface.....	22
11.2.4	Safety chain	22
11.2.5	Status Message Operation - Error	22
11.2.6	Control signal	23
11.2.7	Operation control continuous.....	23
11.2.8	Control via Modbus RTU.....	23
12.	Structure and functions of the control board PCB AIRWIN 3.1	24
12.1	Connections	24
12.2	Functional description of the control functions.....	26
12.3	Default settings.....	27



12.4	Adjustment options PCB AIRWIN 3.1	28
12.5	State diagram	30
12.6	Status Message	31
12.7	LED-Indicator and Decoding	31
12.8	Resetting the maintenance interval	32
12.9	Troubleshooting	33
13.	AquaDrain plus – hygiene management	34
13.1	Description	34
13.2	Features	35
13.2.1	Flushing of water supply line	35
13.2.2	Drainage of fluid tank	37
13.3	AquaDrain plus diagrams	38
14.	Dimensioning of cable cross section	39
15.	Commissioning	42
15.1	Manual functions:	42
15.2	Automatic functions:	43
15.3	Make applied settings:	43
16.	Technical Data	44
17.	Device dimensions / weights	45
18.	Circuit diagrams	46
19.	Care	56
20.	Standards	58
20.1	EC declaration of conformity according to Machinery directive 2006/42/EC, Annex II 1.A	58
20.2	WEEE	58
20.3	Imprint - Copyright	58
21.	List of figures	59
	List of tables	60

1. General Informations and Intended Use

The device is designed exclusively for the humidification of demineralised water according to the technical specifications. Nebulization of other liquids is not permitted.

All AIRWIN ultrasonic duct humidifiers of NKBD-6...42/3.1 series are designed for installation in air handling units.

The power supply must be 48 V-AC. Operation with a different voltage is not permitted and can lead to a defect of the device.

These installation and operation instructions apply to all AIRWIN® ultrasonic duct humidifiers of NKBD-6...42/3.1 series, hereafter referred to as humidifier. It contains important notes for professional installation, start-up, trouble-free operation and proper maintenance and cleaning.

In addition to regular maintenance, proper installation and care of the humidifier help to preserve the value of the device and are conditions for warranty claims.

2. Safety Instructions

The humidifier described in this manual is designed and constructed in accordance with the international safety regulations. Like any other electrical device it has to be handled with care, to ensure safe usage.





In order to guarantee safe operation in all operating conditions, the following safety instructions must be observed.

	<ul style="list-style-type: none"> • The electrical system may only be set up by qualified electricians. In this context, the regulations of DIN VDE series 0100 are fundamental. • The regulations of the local power supplier concerning the electrical connection (e.g.: residual current circuit breaker, additional potential equalisation etc.) must be complied with. • An intended choice of electrical cables and connectors must be used. • Mains voltage and mains frequency of the voltage supply must correspond to the parameters indicated on the identification plate of the humidifier. • Do not connect a damaged humidifier (e.g.: damaged during transport) to the mains. • Contact your customer service if you have any queries about the electrical connection, the features or the security of the humidifier. • Disconnect the humidifier from mains, if it does not work perfectly or if damage has occurred. • Disconnect the humidifier from mains, if the electrical supply line is damaged. • Work on the humidifier may only be carried out as described in these instructions. • Never use high pressure cleaners to clean the humidifier. • Use grease and oil-free materials only.
---	---









3. Scope of delivery

<p>Duct Humidifier NKBD-6...42/3.1</p>  <p>Fig. NKBD-30/3.1</p>	<p>Installation and operating instructions</p> 	<p>Spare part list</p> 
<p>Stop cock Ø 10 mm</p>  <p>Item No. 0002602</p>	<p>Straight reducing connection Ø10 mm Ø6 mm</p>  <p>Item No. 0002362</p>	

4. Optional accessories

Item no.	Type	Description	Illustration
0001196	Tube, PA D/d=10/8 mm, blue	Tube water supply D = 10 mm (blue)	
0001847	Tube, PE D/d=14/11 mm, nature	Tube water drainage D = 14 mm (nature)	
2000105	Mounting brackets	For easy installation of NKBD on a mounting frame in the air duct, made of V2A-stainless steel, incl. adjustable foot. Needs: 2 pcs for NKBD-6 to NKBD-24 3 pcs for NKBD-30 to NKBD-42	
200140..	Vertical frame	To build a mounting frame in the air duct, made of V2A-stainless steel, height adjustable from 500-700 mm or 700-1200 mm or 1200-2000 mm PU = 1 set (2 pcs)	



Item no.	Type	Description	Illustration
200141..	Telescopic strut	To build a mounting frame in the air duct, made of V2A-stainless steel, length adjustable from 500-800 mm or 800-1400 mm or 1400-2000 mm PU = 1 set (2 pcs)	
6100097	BO-80	Duct hygrostat for ON/OFF control of the humidification system, 1-step	
6100095	BO-80/2	Duct hygrostat for ON/OFF control of the humidification system, 2-step	
77001..	ST500 – ST1600	Transformer for control cabinet installation, from 500 VA to 1600 VA, with primary and secondary protection	
77002..	STH500 – STH1600	Transformer in powdered steel housing, with illuminated ON / OFF switch and cable glands from 500 VA to 1600 VA, with primary and secondary protection	
6002100	SUR/P-4b	Control cabinet with room humidity sensor or duct humidity sensor for continuous control	
60121..	SUR/PT...	Control cabinet with room humidity sensor or duct humidity sensor for continuous control and 500, 1000 or 1600 VA Transformer	
8005..	BO-RO...	Reverse osmosis system 6 l/h and more, with permeate storage tank, other models on request	

5. General information

5.1 Technical terms

Transducer	:	Piezo ceramic transducer
Aerosols	:	Finely distributed material (solids or liquids) in air or other gases, manifestations are e.g.: in smoke, dust, vapour and nebula
Demineralised water	:	Pure water, permeate
Concentrate	:	Concentrated water, waste water of reverse osmosis system

5.2 Physical principles of piezo ceramics

If certain crystals are deformed by mechanical stress, electrical charges will build up proportionally on their surface, producing electric field strength in the crystal.

This effect was discovered by Pierre and Jacques Curie in 1880. Even the reversal of this so-called piezoelectric effect or piezo-effect is possible. The same materials change their dimensions under the influence of an electric field.

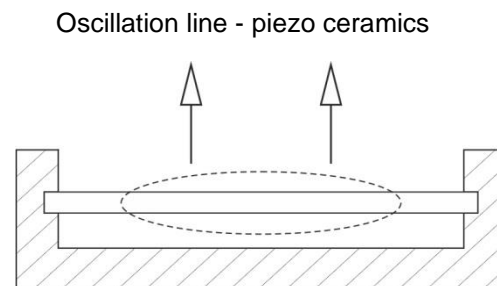

Fig. 1 - Schematic sketch of piezo-effect

Ceramic piezoelectric materials are hard, chemically inactive and completely insensitive to humidity or other atmospheric influences.

5.3 Funktionsbeschreibung Ultraschall-Luftbefeuchter

All frequencies above 20,000 Hz are called ultrasonic.

According to their physical nature, acoustic waves consist of mechanical oscillations of compressible media. These oscillations develop due to the deflection of the particles of a compressible material from their equilibrium position. Acoustic waves are bound to a medium and thus do not occur in the vacuum.

Oscillations develop as a result of a change in pressure. Repeated pressure increase and pressure reduction produce different acoustic waves.

In order to be able to use ultrasonic waves for air humidification, electrical energy must be converted into mechanical energy. This takes place in the piezoelectric transducer.

A vibration unit consists of the resonance circuit where the high frequency of ~ 1.7 MHz is produced and the piezoelectric transducer to convert the electrical frequency into a proportional mechanical oscillation. This frequency is not audible for human beings or animals.

The piezoceramic transducers are attached to the bottom of the fluid tank. During excitation of the transducer, the water leads the ultrasonic vibrations to the boundary layer between water and air. Constant compression and decompression of the water gauge over the transducer causes cavitation in the immediate proximity of the water surface. Thus, crossing capillary waves are developed, the finest water particles of which, the aerosols, are produced in the wave crest.

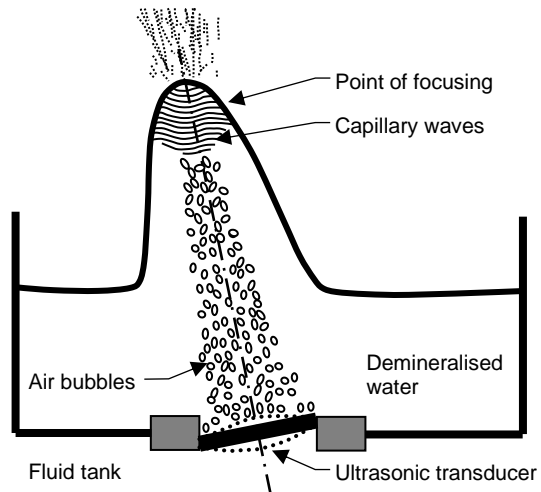

Fig. 2 - Schematic sketch aerosol production

The aerosols are delivered by the air flow in the humidifier and quickly mix with the ambient air. They have a small diameter (0.001 - 0.005 mm) and thus form a freely floating mist. The droplet diameter depends on the surface tension and the density of the medium, but also on the excitation frequency. The higher the excitation frequency, the smaller is the diameter of the droplets.



6. Advantages of ultrasonic air humidification

- 1. maximum energy saving**

Compared to steam and infrared humidifiers with the same humidification output, ultrasonic air humidifiers need up to 93 % less electricity.
- 2. lowest connected load**

Compared to electrode steam humidifiers with the same humidification output, only approx. 7 % of the power input is required. Thus, lower third-party connection costs are possible.
- 3. energy-saving cooling effect**

During humidification with the ultrasonic air humidifiers, the room air is cooled at the same time due to the adiabatic humidification principle. The result is a lower heat load reducing the cooling output requirements.
- 4. lowest water consumption**

Nebulizer humidifiers lose up to 70 % of the water, steam humidifiers up to 30 %. AIRWIN® Ultrasonic air humidifiers do not have any water loss apart from the cyclical emptying process of the fluid tank on AquaDrain plus.
- 5. immediate max. humidification**

Simultaneously with the request impulse, humidification is carried out without any delay.
Exception: during automatic drainage and line flushing.
- 6. max. evaporation of the water**

Ultrasonic air humidifiers produce a very fine aerosol mist. On average, the diameter of the aerosols is only 0.001 - 0.005 mm. Thus, the mist spreads quickly and is taken up by the air after a very short time

7. Equipment overview

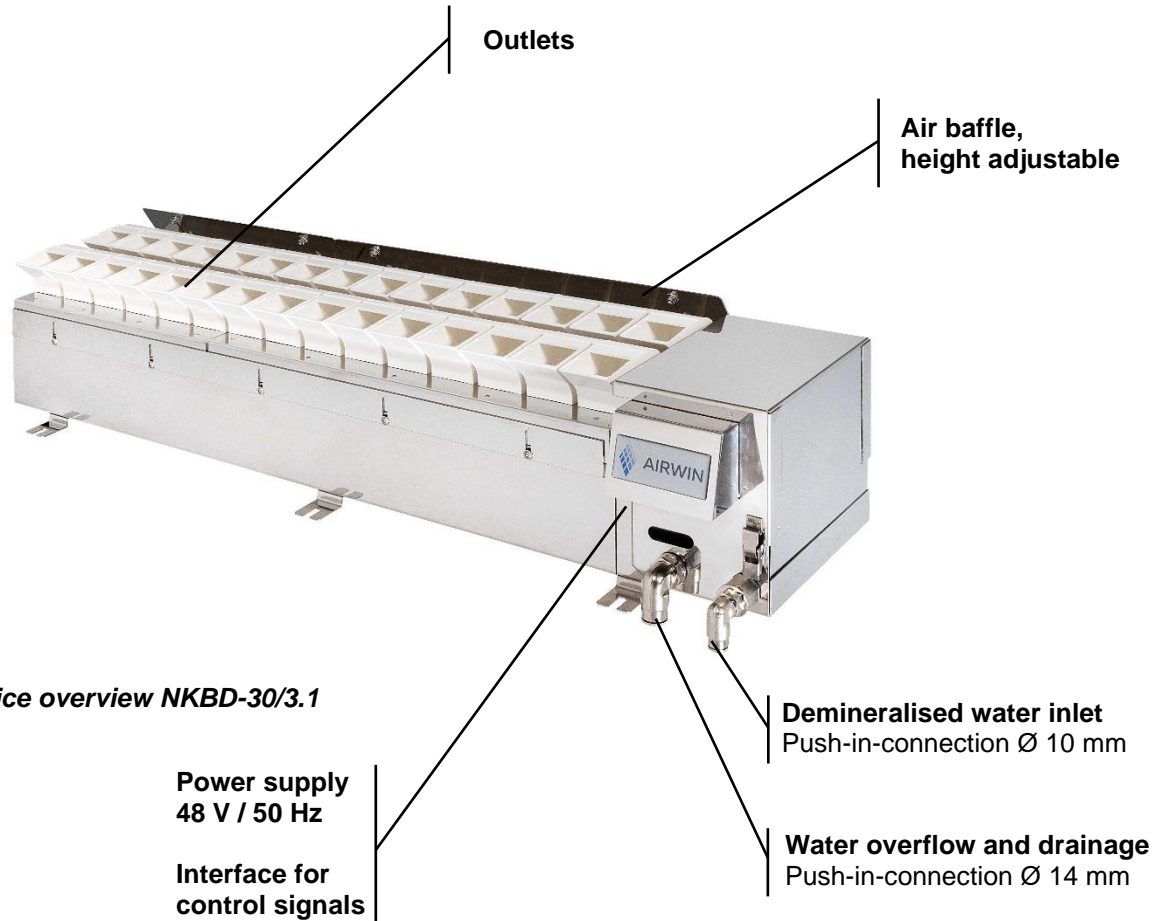

Fig. 3 - Device overview NKBD-30/3.1

8. The NKBD-6...42/3.1-System

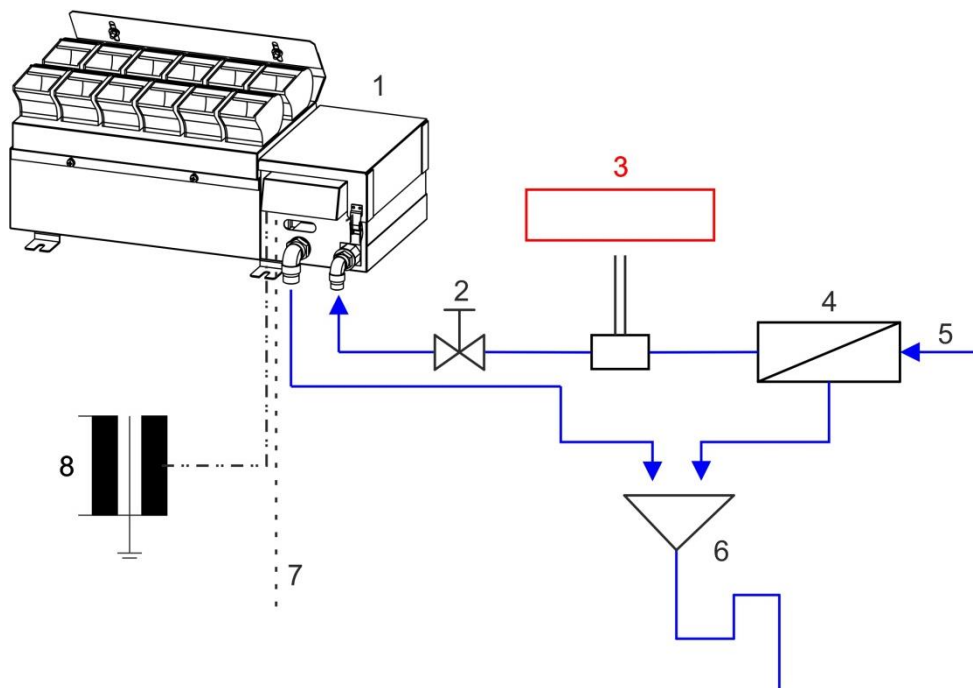

Fig. 4 - Schematic illustration of NKBD-12/3.1 air humidification system

Definitions

1. NKBD
2. Stop cock (included in the scope of delivery)
3. Conductivity meter (e.g.: BO-CM-1) to check the quality of the demineralised water (see optional accessories, REOS product range)
4. Reverse osmosis system (see REOS product range)
5. Drinking water supply (on site)
6. Free discharge according to DIN 1988-100 (on site)
7. External control (hygostat or continuous control signal - see AIRWIN product range)
8. Transformer (see AIRWIN product range)

9. Installation

Proper installation in accordance with the following instructions will ensure trouble-free operation of the humidifier.

The location of the humidifier installation is predetermined by the requirements of the ventilation system and should be defined before installation work starts.



The humidifier must not be exposed to large temperature differences during installation as there is otherwise a danger of condensation inside the humidifier which could lead to a failure of the integrated electronics.



Protect humidifier interiors necessarily from pollution! The protective foil on the exhaust hoods should only be removed immediately prior to commissioning when the air ducts have been cleaned!

9.1 Installation conditions – General notes

- The place of installation must allow the humidifier to be easily removed and replaced.
- The NKBD must be installed in absolutely horizontal position to ensure that ALL the ultrasonic transducers are covered by the same level of water.
- The automatic drainage of the fluid tank and the automatic flushing of the demineralised water line require a free discharge on site according to DIN 1988-100.
- In the immediate vicinity of the duct humidifier, the ventilation unit should be of waterproof design (stainless steel or with corrosion-proof coating) and should be provided with a water discharge outlet.
- The air velocity in the free duct cross section (net area after installation of the humidifiers) $V = 1.0 - 4.0 \text{ m/s}$.
- The distance from the bottom edge of the NKBD to the ceiling of the air duct must be min. 390 mm (Fig. 5 and Fig. 7).
- The distance between the NKBD and the duct/trough base must be min. 100 mm (Fig. 5 and Fig. 7).
- The distance between the NKBD control housing and the duct side wall must be min. 70 mm (Fig. 6 und Fig. 8).
- The distance between the NKBD and the duct side wall must be min. 200 mm (Fig. 6 and Fig. 8).
- Solid objects must not be installed within the humidification distance in order to avoid condensation.

9.2 Installation conditions – special notes

9.2.1 Standard configuration

Mounting example on mounting frame (on site) with mounting bracket NKBD (Item no. 2000105).

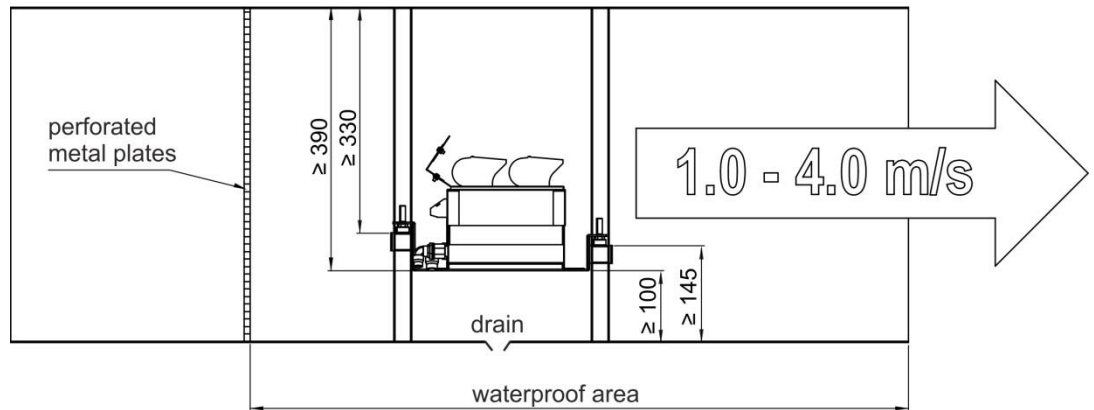

Fig. 5 - Side view into an air duct with one NKBD

The humidifiers can be arranged directly one above the other. The vertical distance between the humidifiers should be ≥ 140 mm.

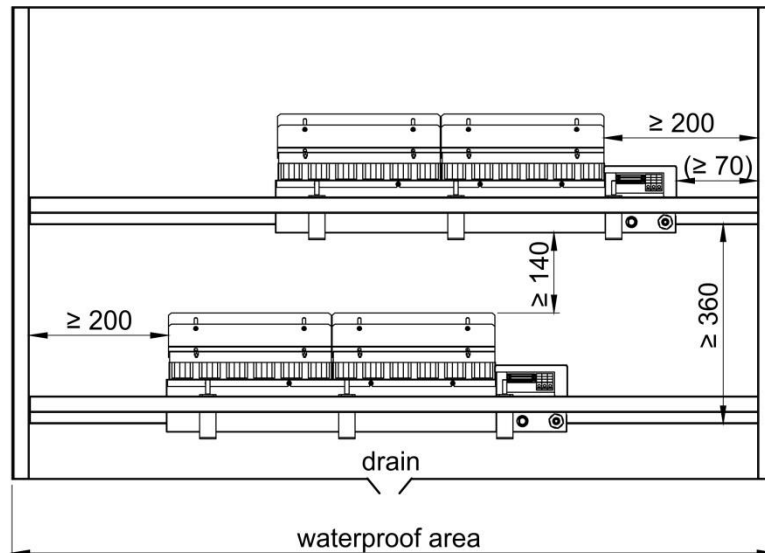

fig. 6 - View into an air duct in direction of air flow, two NKBD mounted one above the other

9.2.2 Stepped configuration

Humidifiers are mounted one above the other; offset horizontally (Fig. 7 and Fig. 8). Mounting example on mounting frame (on site) with NKBD mounting brackets (Item No. 2000105).

Stepped configuration is necessary

- if the permissible air velocity would be exceeded on standard configuration or
- if more humidification is necessary than would be possible with the standard configuration. The minimum vertical distances are smaller than with the standard configuration, which permits installation of more units and thus increased humidification.

Requirements:

- With stepped configuration, the vertical distance between several humidifiers must be ≥ 70 mm
- The minimum horizontal distance between several humidifiers must be ≥ 80 mm.
- Several humidifiers should be evenly distributed over the entire duct width, observing the minimum distance of 200/100 mm from the duct walls.

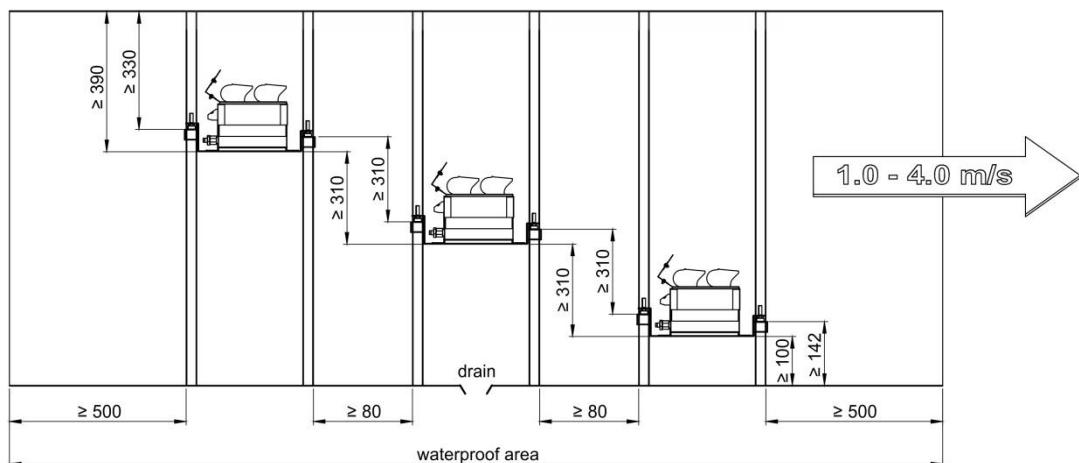

Fig. 7 - Side view into an air duct with three NKBD

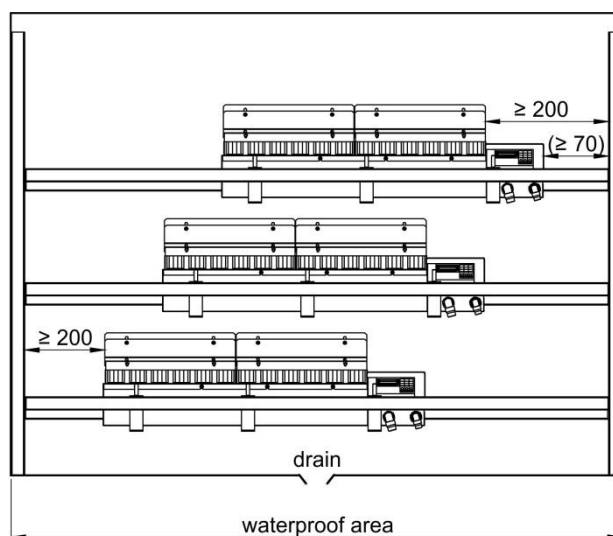

Fig. 8 - View into an air duct in direction of air flow, three NKBD mounted above each other

9.3 Suction operation

During suction operation is to ensure that the aerosol mist of the humidifiers is not constricted by the suction of the fan! As may be the case fit a 50 % perforated plate - consider pressure loss!

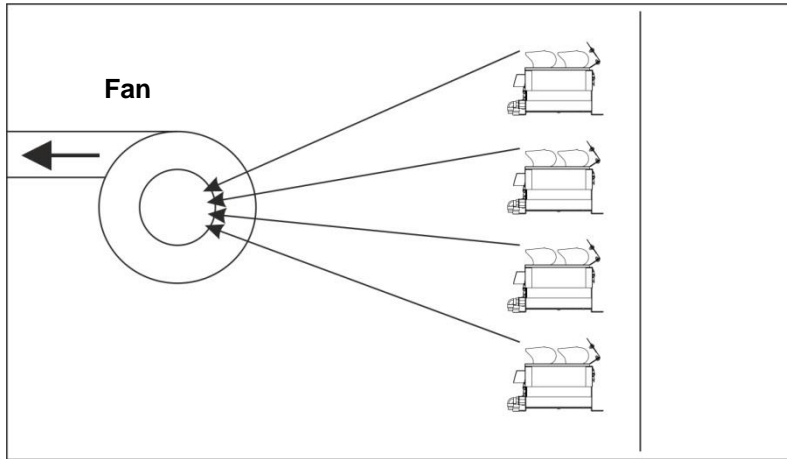

Fig. 9 - Side view NKBD in the air duct

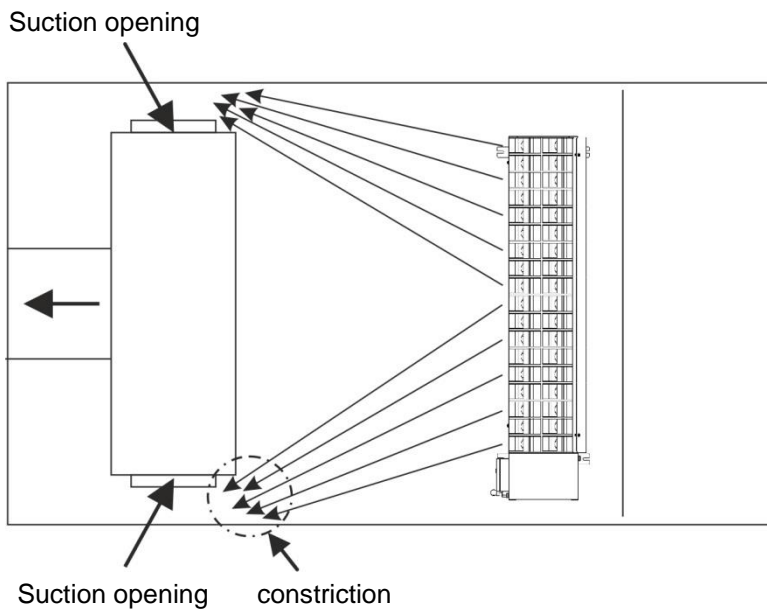

Fig. 10 - Top view NKBD in the air duct

	Avoid constriction of the aerosol mist!
--	---

9.4 Recommended settings of the airflow

9.4.1 Folded sheet and extension on the body duct support

Set the folded sheet at the minimum distance to the body duct support for the first setting.

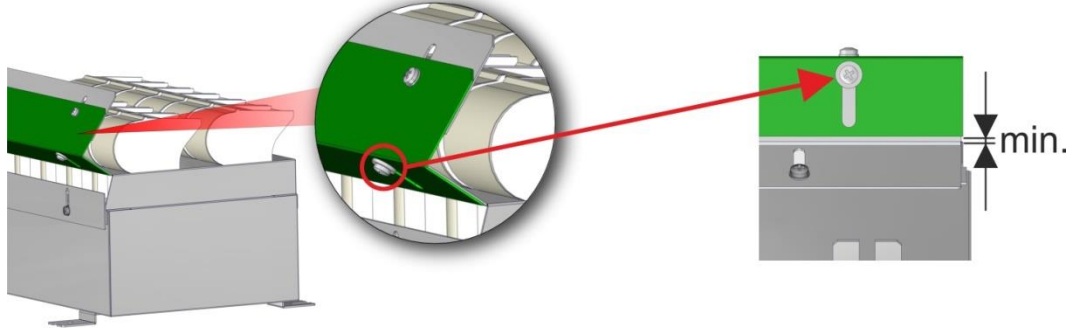

Fig. 11 - Set folded sheet

In addition, the extension is set at the maximum distance to the folded sheet.

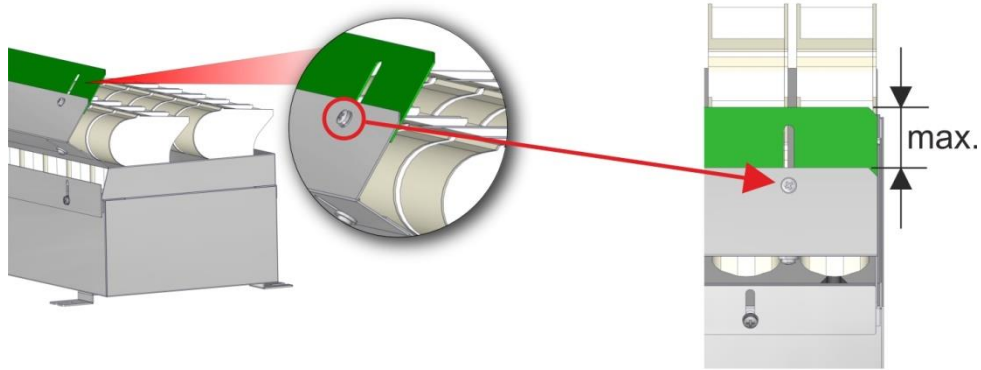

Fig. 12 - Set extension

9.4.2 Closing sheet on the tank cover

The air inlet slit is set to a minimum by the closing sheet.

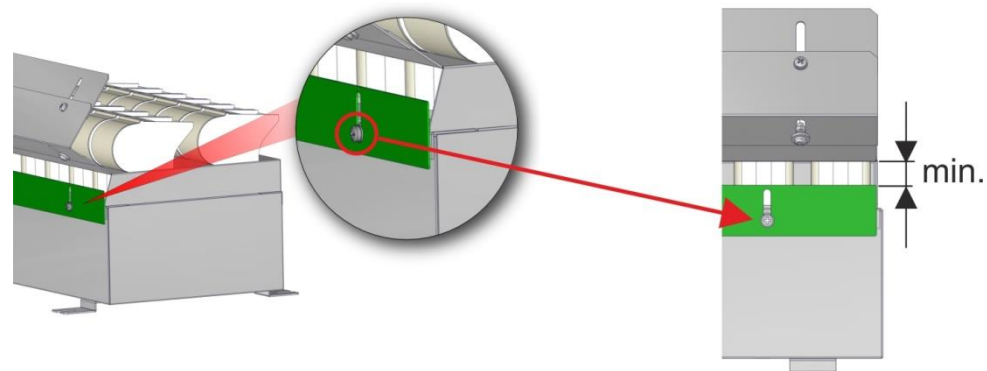

Fig. 13 - Set closing sheet



Depending on the duct design and air velocity, these basic settings can be modified to optimize the humidification capacity.

9.5 Adjustment of the NKBD to the direction of airflow

The NKBD can be adjusted to the flow direction of the duct air. Therefore, if required, the duct support must be rotated by 180° and the closing sheet must be mounted on the opposite side. This allows the humidifier to be situated in a favourable position for the water and electrical connection.

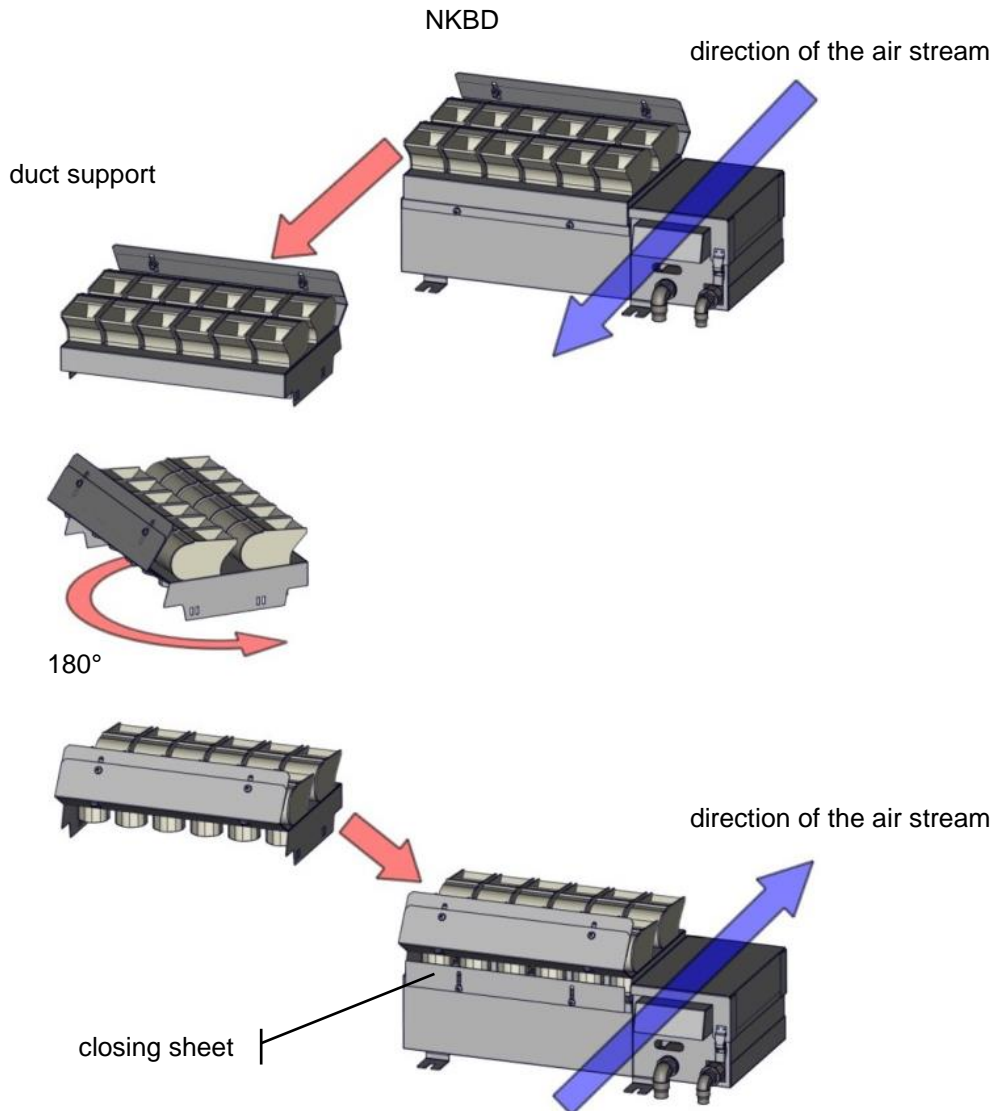

Fig. 14 - Rotate duct support

10. Hydraulic connection

10.1 Hydraulic conditions

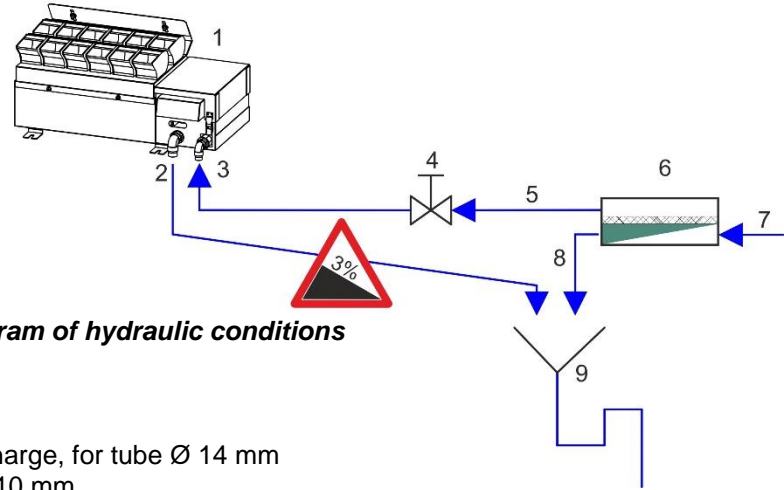

Fig. 15 - Schematic diagram of hydraulic conditions

Definitions

1. NKBD-12/3.1
2. Water overflow and discharge, for tube \varnothing 14 mm
3. Water supply for tube \varnothing 10 mm
4. Stop cock (included in the scope of delivery)
5. Demineralised water:
1 bar < pressure \leq 4 bar
 $5 \mu\text{S/cm}$ < conductivity \leq 20 $\mu\text{S/cm}$
6. Water demineralisation system (reverse osmosis system)
7. Drinking water supply (on site)
8. Concentrate
9. Free discharge according to DIN 1988-100 (on site)

Important notes:

- The humidifier may be operated with fully demineralised water only (produced for example by a reverse osmosis system). The demineralised water must have a conductivity of min. 5 $\mu\text{S/cm}$ and max. 20 $\mu\text{S/cm}$.
- The contamination of drinking water may not exceed the max. values laid out in the drinking water regulations
- The demineralised water is corrosive, therefore use stainless steel or plastic only. Non-ferrous metals (e.g.: copper, brass) must not be used.
- Water pressure must be minimum 1 bar and maximum 4 bar.
- The drainage system on site must be set in accordance with DIN 1988-100.
- The water overflow- and discharge pipe must be laid with a constant slope of min. 3% (3 cm on 1 m) to the free discharge.
- For easy revision, the stop cock included in the scope of delivery must be installed in the demineralised water supply line close to the device.



All materials coming into contact with the demineralised water must be resistant to demineralised water. Water pipes and tubes must be flushed prior to starting the humidifier.

10.2 Establishing and detaching the connections with connectors

The connectors provide durable, safe and watertight connections between tube and connecting element. The tube is simply inserted by hand. The retaining element holds the tube safely without pressing it or decreasing the flow.

Establishing the connection

Cut tube squarely and free of burrs.
Make sure that the tube has no sharp edges, longitudinal grooves or other damage.

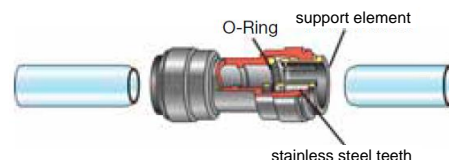

Fig. 16 - Establishing the connection

Connection is stable prior to sealing

Insert the tube up to the stop.
The supporting element holds the tube in the connector. With the help of the o-ring, a tight connection is established.



Fig. 17 - Insert tube

Check the connection by pulling towards the opposite side

By pulling towards the opposite side check whether the tube was safely inserted.
Then slide on the locking ring.

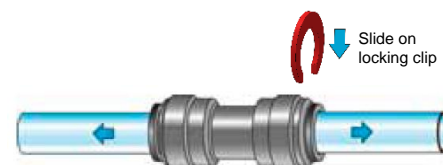

Fig. 18 - Check connection

Detaching the connection

First remove the locking ring.
The tube can be detached by pushing back the supporting element.

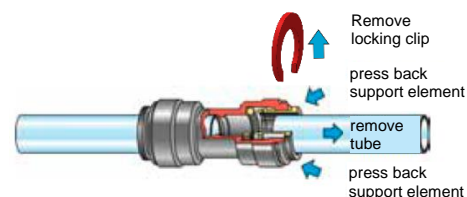



Fig. 19 - Detaching the connection

	<p>All pipes, tubes and connecting elements must be resistant to demineralised water.</p> <p>The surface hardness of pipes and tubes must not exceed 225 HV. Otherwise the retaining teeth in the connector do not securely hold on it.</p> <p>Soft tubes are also to be avoided.</p>
---	---

11. Electrical Connection

11.1 Transformer

- The transformers are available either loose or installed in a sheet metal housing. When installing in the control cabinet, it is essential to make allowance for the heat dissipated from the transformers. The control cabinet may have to be provided with forced-air cooling.
- A single large transformer may be selected to serve several humidifiers. In such cases, make sure that each outgoing secondary circuit is fuse-protected, either external in the control cabinet or within the transformer ex- factory.
- The transformer transforms the primary voltage of 230 V / 50 Hz to the secondary voltage of 48 / 53 V.
- The power connection cable leading to the transformer and from the transformer to the humidifier must at least satisfy H05VV or H05RR specifications.
- The transformers of BOGA are manufactured according to the following specifications: Single-phase control-power transformer in accordance with VDE 0550 Parts 1+3 and VDE 0113, IP00, Protection Class 1, Insulation Class T40E, separate windings, screw-connection in accordance with VBG4, 50/60 Hz.

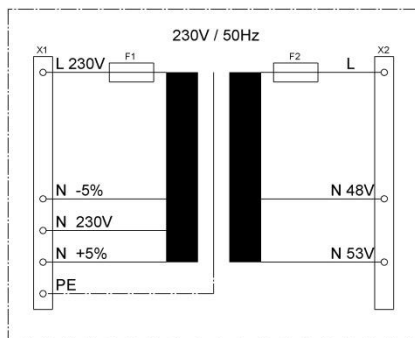

Fig. 20 - Transformer with one secondary output

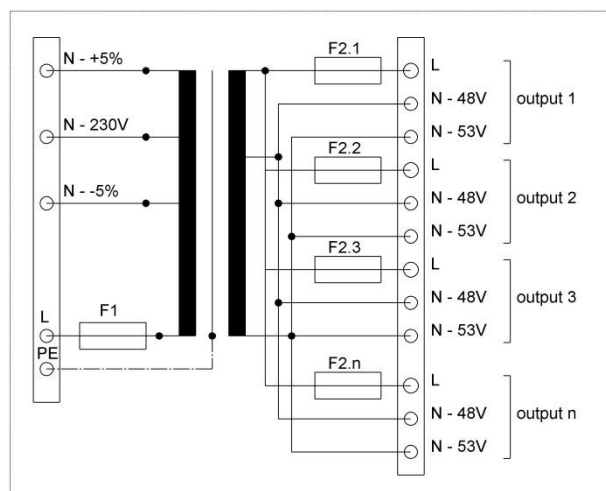



Fig. 21 - Transformer with multiple secondary outputs



The neutral conductor (N) on the secondary side must not be earthed!

11.2 Humidifier

The electrical connection of the humidifier is made for the electrical power at the 48 V (L, N, PE) bushing terminals and for the regulation, control, safety chain, status message and function control at the 14-pole plug connector in the middle part of the control housing. The terminals are exposed when you release the fasteners on the control housing cover and remove the cover.

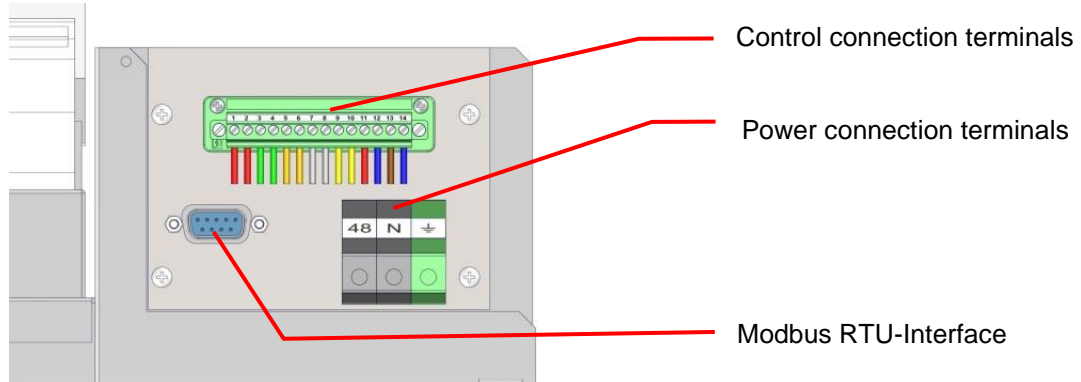

Fig. 22 - Electrical connections

11.2.1 Power connection

Tab. 11-1 - Assignment of power connection terminals

Connection	Name of terminal
L 48 V-AC	48
N 48 V-AC	N
PE	protective earth

11.2.2 Control connection

Tab. 11-2 - Assignment of control connection terminals

Contact	Description	Information
1	Safety chain 48 V-AC or - 24 V-DC	Observe the polarity (DC)
2	Safety chain 48 V-AC or + 24 V-DC	Observe the polarity (DC)
3	Error message ST-2 (normally open contact)	Error message
4	Error message ST-2(normally open contact)	Error message
5	Operation message ST-1 (normally open contact)	Operation message
6	Operation message ST-1 (normally open contact)	Operation message
7	Input Hygrostat 1	50 % Output Capacity
8	Input Hygrostat 1	50 % Output Capacity
9	Input Hygrostat 2	100 % Output Capacity
10	Input Hygrostat 2	100 % Output Capacity
11	Control signal input + 4 ... 20 mA	Observe the polarity Impedance 500 Ω
12	Control signal input - 4 ... 20 mA	Observe the polarity Impedance 500 Ω
13	Control signal input + 0 ... 10 V	Observe the polarity Impedance 50 KΩ
14	Control signal input - 0 ... 10 V	Observe the polarity Impedance 50 KΩ

11.2.3 Modbus RTU-Interface

Tab. 11-3 - Assignment of D-SUB socket

PIN	Description
1	BOGA MODBUS RTU < COMMON >
5	BOGA MODBUS RTU < B/B' >
9	BOGA MODBUS RTU < A/A' >

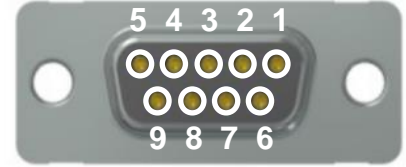
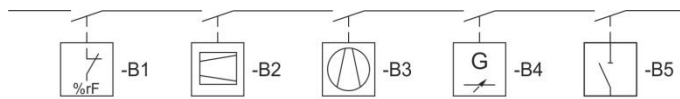

Fig. 23 - D-SUB socket

11.2.4 Safety chain

Connect safety chain to the screw-type connectors marked 1 and 2. Observe the 48 V-AC or 24 V-DC power supply.



- B1: limit hygrosstat
- B2: flow monitor
- B3: fan locking
- B4: conductivity measurement
- B5: ON/OFF switch

Fig. 24 - Safety chain

	<p>The input of the safety chain must always be supplied with 48 V AC (alternatively 24 V DC) voltage. Otherwise the humidifier will NOT work! If several humidifiers are connected to the safety chain, they must be connected in parallel to each humidifier. ATTENTION: The feed may only be done once.</p>
--	--

11.2.5 Status Message Operation - Error

There are two signal outputs via PhotoMOS relay.

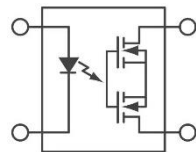

- U_{max} : 24 V-DC
- I_{max} : 50 mA
- R_{on max} : 25 Ω

Fig. 25 - PhotoMOS Relais

Tab. 11-4 - Status messages operation / error

Status message	Message type	Connection terminal on the green plug
1	Operation message	5 + 6
2	Collective Error message	3 + 4

11.2.6 Control signal

The NKBD can process 2 different external controlled variables.

- 0-10 V-DC
- 4-20 mA

Input resistances (Load)

<u>Control variable</u>	<u>Input Impedance</u>
0-10 V-DC	50 k Ω
4-20 mA	500 Ω

11.2.7 Operation control continuous

The humidifier can process different external analog input signals.

The output power can be controlled in the smallest stages between 0% and 100% humidifier output.

- 0-10 V-DC (Standard factory setting)
- 4-20 mA (Standard factory setting)

Tab. 11-5 - Thresholds analog input

Control signal	Out PWM ON	Out 100 %	Out PWM OFF
0-10 V	1.1 V \pm 0.5	8.5 V \pm 0.5	0.9 V \pm 0.5
4-20 mA	5.4 mA \pm 0.1	18.5 mA \pm 0.5	5.2 mA \pm 0.1
1-10* V	2.1 V \pm 0.5	8.5 V \pm 0.5	2.0 V \pm 0.5
0-20* mA	1.7 mA \pm 0.1	18.0 mA \pm 0.5	1.5 mA \pm 0.1

(*) = Control signal optionally adjustable at the factory

11.2.8 Control via Modbus RTU

The NKBD can also be controlled via BOGA Modbus RTU.

Further information can be found in the BOGA Modbus RTU interface description. This can be requested from the manufacturer or viewed and downloaded from the www.boga.de website.

12. Structure and functions of the control board PCB AIRWIN 3.1

12.1 Connections

Inputs

X9 - Connection of float switch:

- 1: Float switch, level "S1" black
- 2: Float switch, level "S1" brown
- 3: Float switch, level "S1" blue
- 4: Float switch, level "S1" grey

- 5: Float switch, level "S2" black
- 6: Float switch, level "S2" brown
- 7: Float switch, level "S2" blue
- 8: Float switch, level "S2" grey

X8 - Connection sensor:

- 1: Current measurement -
- 2: Current measurement +

Notice:

Only connections relevant to the device are shown.

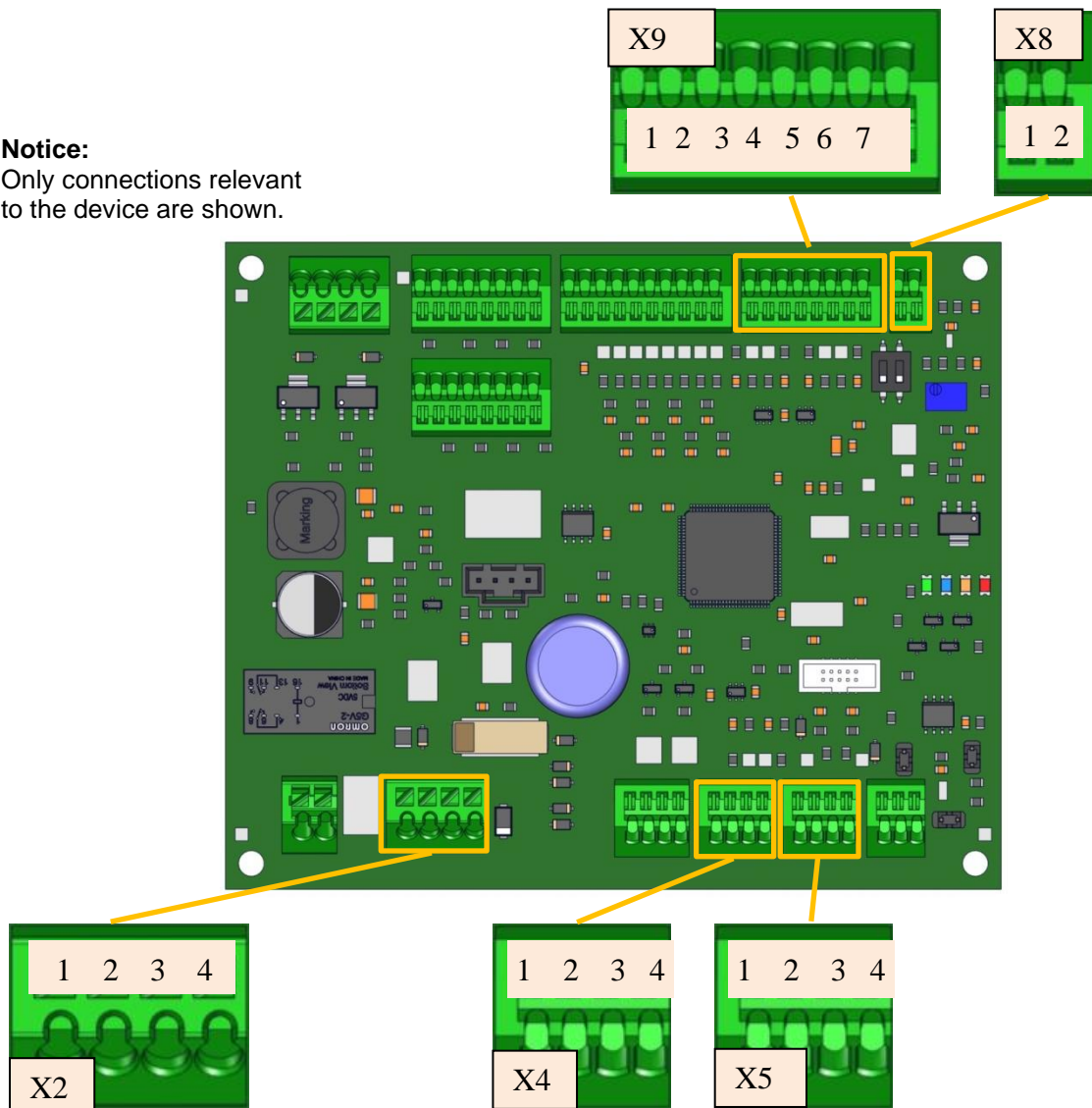

Fig. 26 - Control board PCB AIRWIN 3.1 Input

X2 - Connection to supply:

- 1: Power supply L 48 V-AC
- 2: Power supply N 48 V-AC
- 3: Release 48 V-AC, 24 V-DC
- 4: Release 48 V-AC, 24 V-DC

X4 - Connection hyg:

- 1: Hygrostat input 1
- 2: Hygrostat input 1
- 3: Hygrostat input 2
- 4: Hygrostat input 2

X5 - Connection Reg:

- 1: Control signal mA + (Ri: 500 Ω)
- 2: Control signal mA -
- 3: Control signal V + (Ri: 50 kΩ)
- 4: Control signal V -

Outputs

X7 - Connection of solenoid valves

- 1: Solenoid valve drain L+
- 2: Solenoid valve drain N-
- 3: Solenoid valve supply L+
- 4: Solenoid valve supply N-

X12 - Connection of oscillator boards:

- 1: PWM 4 - 5: PWM 2 -
- 2: PWM 4 + 6: PWM 2 +
- 3: PWM 3 - 7: PWM 1 -
- 4: PWM 3 + 8: PWM 1 +

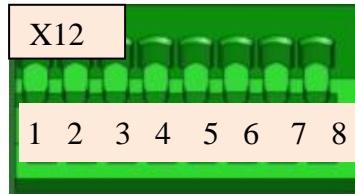
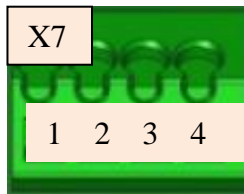

Notice:
Only connections relevant to the device are shown.

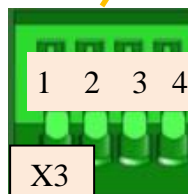
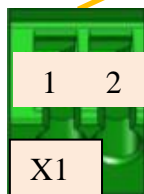
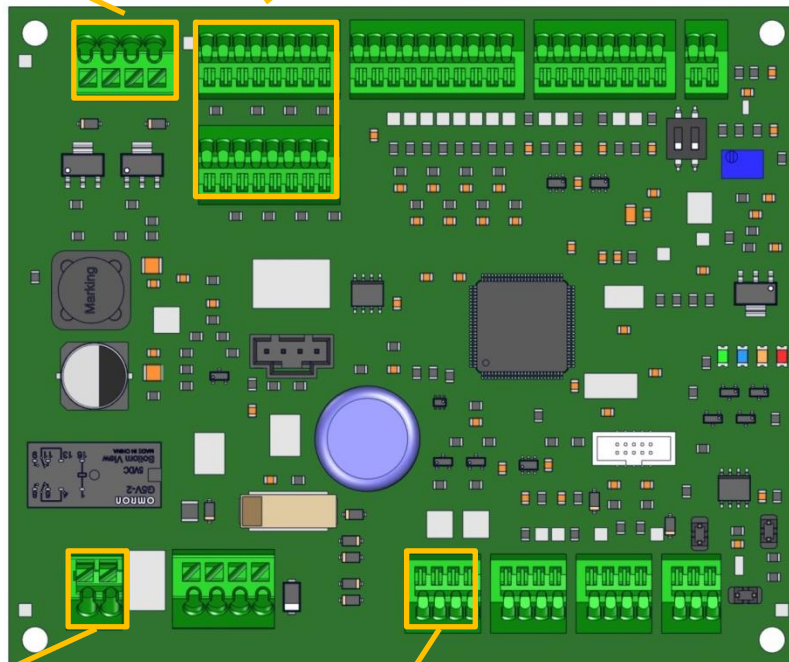

Fig. 27 - Control board PCB AIRWIN 3.1 Outputs

X1 - Connection Fan*:

- 1: Relay closing contact
- 2: Relay closing contact

X3 - Status reports:

- 1 + 2: Status message 1 (Operation)
- 3 + 4: Status message 2 (Error)

*) not used for NKBD

12.2 Functional description of the control functions

Current measurement of the oscillator boards

In this configuration, a current check of the oscillator boards is performed every 3 hours. **This test only takes place when the humidification request is present and lasts max. 5 seconds. During this time, the humidifying power is set to 100% and a functional test of all transducers is performed.**

Change of the level control

Since the level control in the humidifier is an important control, the two existing level float switches are monitored simultaneously. A digital evaluation of the states of both float level levels reliably detects critical and impermissible states.

Check and holding voltage of the solenoid valves

The current consumption of the solenoid valves is checked before and during filling. If a fault is detected, the status message ST-2 (error) forwards this information.

Further monitoring-routines

Optionally there are monitoring routines for the filling (maximum filling time) and monitoring routines for emptying the fluid tray (maximum drainage time). If a fault is detected, an automatic problem-solving routine will attempt to correct this fault. Furthermore, it is possible to monitor the function of the fan, solenoid valve supply and solenoid valve drain via a current measurement.

If a system component does not work correctly, status message ST-2 (error) forwards this fault information.

The default settings of the control board PCB AIRWIN 3.1 are shown in Tab. 12-1.



12.3 Default settings

Tab. 12-1 - Default settings PCB AIRWIN 3.1

	Parameter	NKBD-6/3.1	NKBD-12/3.1	NKBD-18/3.1	NKBD-24/3.1	NKBD-30/3.1	NKBD-36/3.1	NKBD-42/3.1
Time Constants	AquaDrain Duration	3 min.	4 min.			5 min.		
	AquaDrain Cycle Time	12 hours						
	AquaDrain Delay	disabled						
	Flush Time	120 seconds						
	Inactivity Flush Timeout	12 hours						
	Inactivity Drain Timeout	12 hours						
	Humdification Timeout	disabled						
	Fill Timeout	15 minutes						
Current Measurement	Inlet Valve	enabled						
	Outlet Valve	enabled						
	Fan	disabled						
	Oscillator	enabled						
	Oscillator Check Intervall	3 hours						
IOs	Voltage Input Scale	0-10 V DC						
	Voltage Input Functionality	active						
	Current Input Scale	4-20 mA						
	Current Input Functionality	active						

12.4 Adjustment options PCB AIRWIN 3.1

AquaDrain Duration:

The AquaDrain duration is the time the humidifier needs to empty the fluid tray. This value is given by design and depends on the type of humidifier, the size of the fluid tray and the installation.

Possible settings: 30 seconds, 1 minute, 2 minutes, 3 minutes, 4 minutes, 5 minutes, 6 minutes.

Default setting: depending on the device type (Tab. 12-1)

AquaDrain Cycle Time

The AquaDrain cycle time is directly linked to the automatic emptying of the fluid tray. The AquaDrain process is also performed when there is a humidification request.

Possible settings: Disabled, 10 minutes, 30 minutes, 1,5 hours, 3 hours, 6 hours, 12 hours, 24 hours, 48 hours.

Default setting: 12 hours

AquaDrain Delay

The AquaDrain delay is used when several humidifiers are mounted in a system and AquaDrain is enabled. The AquaDrain delay prevents all humidifiers from being emptied at the same time.

Possible settings: No delay, 1 x 15 minutes, 2 x 15 minutes, 3 x 15 minutes, 4 x 15 minutes, 5 x 15 minutes, 6 x 15 minutes, 7 x 15 minutes

Default setting: No delay

Flush Time

The flushing time is the time at which the water supply line is flushed before the first operation and after a certain period of inactivity.

Possible settings: 15 seconds, 30 seconds, 120 seconds, 200 seconds

Default setting: 120 seconds

Inactivity Flush Timeout

The "Inactivity Flush Timeout" causes the water supply line to be flushed after a specified time. If the internal fluid tank is empty and the humidifier is in idle mode for this adjustable time, the water supply line is flushed before the internal fluid tank is filled again.

Possible settings: Default setting, 10 minutes, 30 minutes, 1,5 minutes, 3 hours, 6 hours, 12 hours, 24 hours, 48 hours.

Default setting: 12 hours



Inactivity Drain Timeout

If no humidification is requested, the humidifier is in standby mode. If the fluid tank is still filled, it is automatically emptied after the adjustable time "Inactivity Drain Timeout".

Possible settings: Default setting, 10 minutes, 30 minutes, 1,5 hours, 3 hours, 6 hours, 12 hours, 24 hours, 48 hours.

Default setting: 12 hours

Humidification Timeout

The humidification timeout is implemented to check for possible water quality errors. If the humidifier operates for an adjustable amount of time and does not refill, the water may be dirty and cannot be misted. When the "Humidification Timeout" time has elapsed, the humidifier checks the function of the level switches, empties the liquid tank and refills it to remove the contamination. Another cause of this error could be a lack of airflow. This problem-solving process runs three times. If the problem-solving process is unsuccessful, the humidifier will enter the error mode and display the "Humidification Timeout" error.

Possible settings: Disabled, 5 minutes, 30 minutes, 1,5 hours, 3 hours, 6 hours, 12 hours, 24 hours, 48 hours.

Default setting: disabled

Fill Timeout

The "Fill Timeout" is the time the humidifier needs to fill the fluid tray. When the time for filling expires, without reaching the necessary fluid level in the fluid tray, a fill error has occurred and a problem solving routine is activated. If the error cannot be cleared, the humidifier displays the "Filling Error". The time to fill depends on the water supply pressure and the type of humidifier.

Possible settings: Deaktiviert, 5 minutes, 10 minutes, 15 minutes, 30 minutes, 60 minutes.

Default setting: 15 minutes

Oscillator Check Intervall

The oscillators can be automatically checked after a certain time. If the time interval has expired and a humidification request is present, the humidifier will operate for a short time (approximately 5 seconds) with 100% humidification performance.

Possible settings: Disabled, 5 minutes, 10 minutes, 15 minutes, 30 minutes, 1,5 hours, 3 hours, 6 hours, 12 hours, 24 hours, 48 hours.

Default setting: 3 hours

Changes to the default values can be made by prior arrangement presettet ex works.

12.5 State diagram

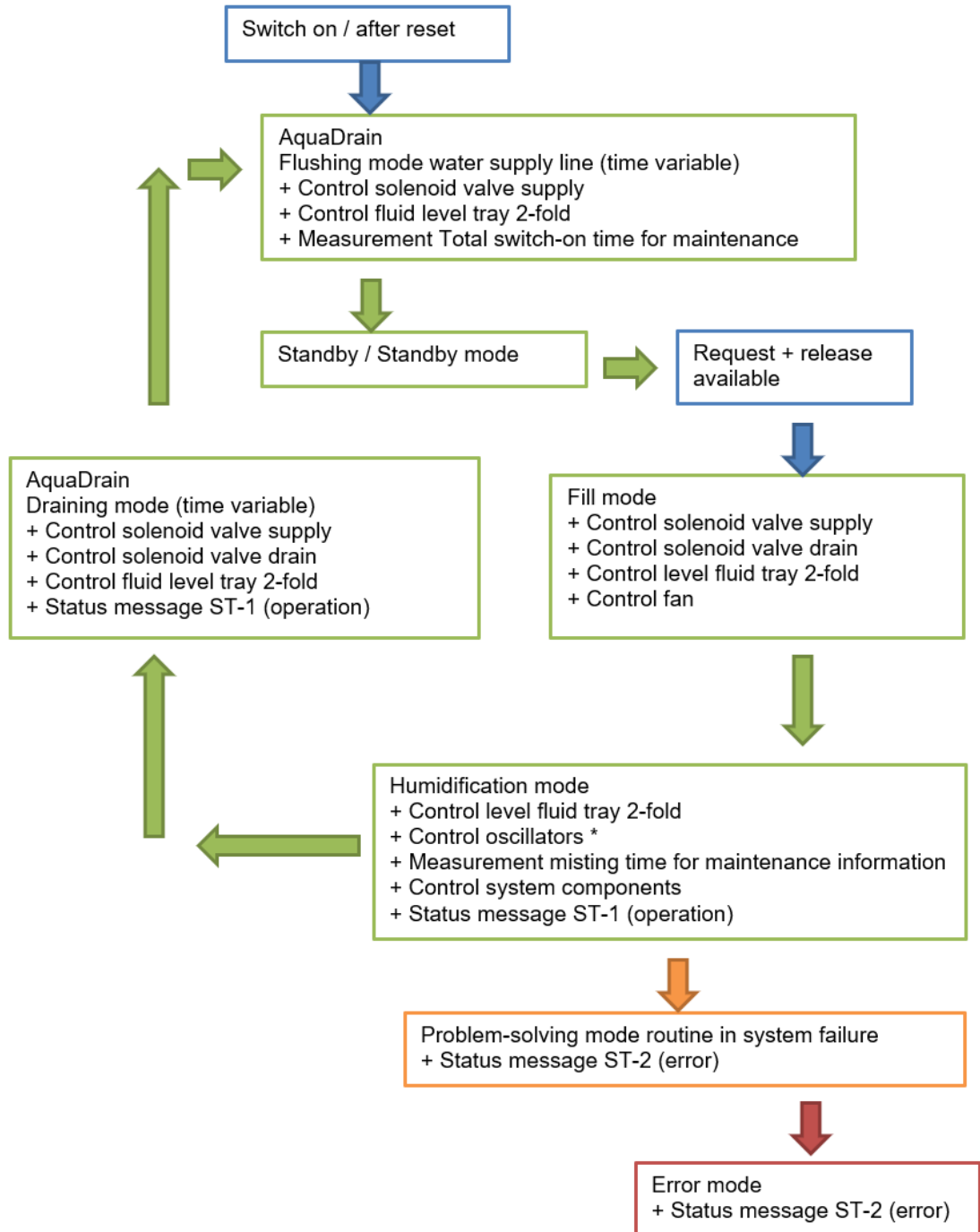

Fig. 28 - State diagram

*: During the “control Oscillators”, the nebulization output is automatically increased to 100% in the humidification mode for a maximum of 5 seconds

12.6 Status Message

Tab. 12-2 - Status messages - System States

System State	Operational message
Device switched off no supply voltage	Contact open
Humidification activ	Contact closed
Humidification inactiv	Contact open

System State	Error message
Device switched off / no supply voltage	Contact open
Normal operation	Contact closed
Fault Mode – Error Mode	Contact open

12.7 LED-Indicator and Decoding

There are 4 different colored LEDs on the control board PCB AIRWIN 3.1. Using different flashing and light frequencies all system states are displayed here.

Information about the next service (5,000 working hours) or maintenance interval (10,000 working hours) is also displayed here.

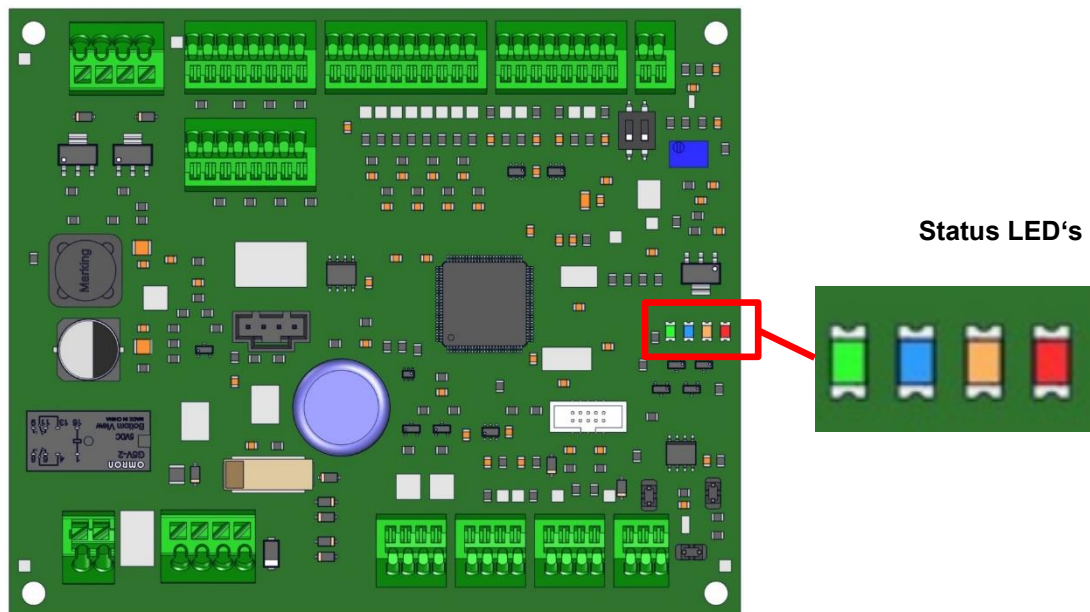

Fig. 29 - Control board PCB AIRWIN 3.1

LED green	LED blue	LED orange	LED red		
		1	1	Fehler Füllen (Füllen Timeout) Error filling (Fill Timeout)	Fehlercode / error code
		2	1	Fehler Entleeren (Entleeren Timeout) Error draining (Drain Timeout)	
		1	∞	Fehler Strommessung Magnetventil-Zulauf Error current measurement supply valve	
		2	∞	Fehler Strommessung Magnetventil-Ablauf Error current measurement drain valve	
		3	∞	Fehler Strommessung Lüfter Error current measurement fan	
		4	∞	Fehler Strommessung Oszillatorplatten Error current measurement oscillator boards	
		3	1	Fehler Vernebelung Timeout Error nebulisation timeout	
		4	1	Fehler Niveauschalter Error level switch	
∞			3	Bereitschaft (keine Freigabe & keine Anforderung) Standby (no release & no requirement)	Zustand / status
∞		∞		Vernebelung Nebulisation	
∞		1		Problemlöseroutine Problem solving	
∞		2		Spülung Flushing	
∞		3		Entleeren Draining	
∞		4		Wanne auffüllen & Lüfter Vorlauf Fill tank & fan pre-run	Wartung / maintenance
	1			Wartung 1 (5.000 Std.) Maintenance 1 (5,000 hours)	
	∞			Wartung 2 (10.000 Std.) Maintenance 2 (10,000 hours)	
∞			1	Befeuchtungsanforderung nicht vorhanden Humidification request not available	
∞			2	Freigabe nicht vorhanden Release not available	
		4	4	Unbekannter Fehler Unknown error	

Die Zahl gibt die Anzahl der Lichtimpulse der LED an. The number indicates the number of light pulses of the LED.

∞ = dauerhaft an

∞ = permanently on

Fig. 30 - Decoding LED-Display

12.8 Resetting the maintenance interval

The resetting of the LED display may only be carried out by trained specialists.
After service or maintenance has been carried out, the LED display can be reset as follows:

1. Switch off the device and let it drain.
2. Remove the duct support.
3. Deactivate the safety chain by removing the control unit plug.
4. Switch on the device, wait for the rinsing cycle and the AquaDrain plus Duration.
5. Do the following action 5 times in a row.
6. Raise level switch S2 to the upper level, wait 1 second and then move it back to the lower level.
7. If the reset of the maintenance interval successful, the LED has gone out.
8. If the LED does not go out, repeat the process.
9. Put the duct support back on and activate the safety chain.

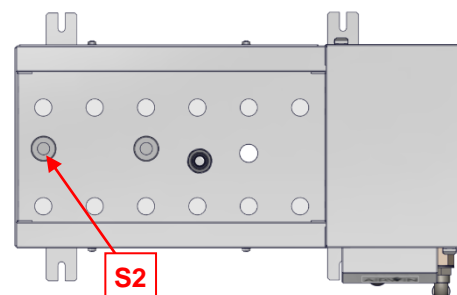

Fig. 31 - Level switch S2

12.9 Troubleshooting

Tab. 12-3 - Troubleshooting checklist

Error	Displayed error	Significance	Check installation	Check	Check control system	Elimination
No humidification	Error filling	The device is not filled within the specified time	Check inlet water pressure > 1 bar	Check water sieves	Check control unit settings	Restart humidifier
	Error draining	The device is not emptied within the specified time	Free drain available?	Check fluid tank for cleanliness and clean if necessary Function magnetic valve, check sequence	Check control unit settings	Restart humidifier
	Error current measurement supply valve	The solenoid valve supply is not activated	Solenoid valve coil connected?	Function magnetic valve, check inlet	Check control unit settings	Restart humidifier
	Error current measurement drain valve	The solenoid valve drain is not activated	Solenoid valve coil connected?	Function magnetic valve, check discharge	Check control unit settings	Restart humidifier
	Error nebulisation timeout	A refilling of the fluid tank did not take place during the specified duration (humidification timeout)	Water quality in accordance with technical specifications? Air flow available?	Function magnetic valve, check inlet Cleaning the fluid tank and level switch	Check control unit settings	Restart humidifier
	Error level switch	Level switch values are not plausible	Check exact horizontal installation	Check fluid tank for contamination. Check level switch functions		Restart humidifier Change level switch
	Unknown Error	Unknown error	Check connection of the device	Check for visual defects	Check control unit settings	Disconnect the power supply for at least 1 minute and then restart
Humidification performance dropped	Error current measurement oscillator boards	The power of the oscillators deviates from the reference value outside the tolerance range	Optical control of the transducer.	Check the function of the transducer visually Check service status	Check control unit settings	Restart humidifier

13. AquaDrain plus – hygiene management

13.1 Description

AquaDrain plus is a system designed to flush the demineralised water inlet pipe to the humidifier according to various parameters and to cyclically empty the fluid tank of the NKBD. To do so, AquaDrain plus uses certain software and a solenoid valve combination integrated in the housing of the humidifier. In addition, AquaDrain plus prevents that the fluid tank is refilled with water, which had been reduced by evaporation, during the humidification-free periods of the AquaDrain plus cycle.

The AquaDrain plus cycle is the cycle in which the humidifier, minus the time for flushing the water inlet pipe and draining of the fluid tank, can humidify continuously, but does not necessarily have to do so. The AquaDrain plus cycle is 12 hours and the cycle was preset in the factory. Optionally this setting may be changed by the manufacturer see chapter 12.1.4.

If several humidifiers are installed in a system and AquaDrain plus is activated, the AquaDrain plus delay can be used to prevent all humidifiers from being emptied at the same time. For optional factory settings, see chapter 12.4.

Definitions

1. Humidifier
 - 1.1. Solenoid valve drain, integrated
 - 1.2. Solenoid valve supply, integrated
2. Water overflow and drainage
3. Water supply
4. Demineralisation system (reverse osmosis system)
5. Water drainage

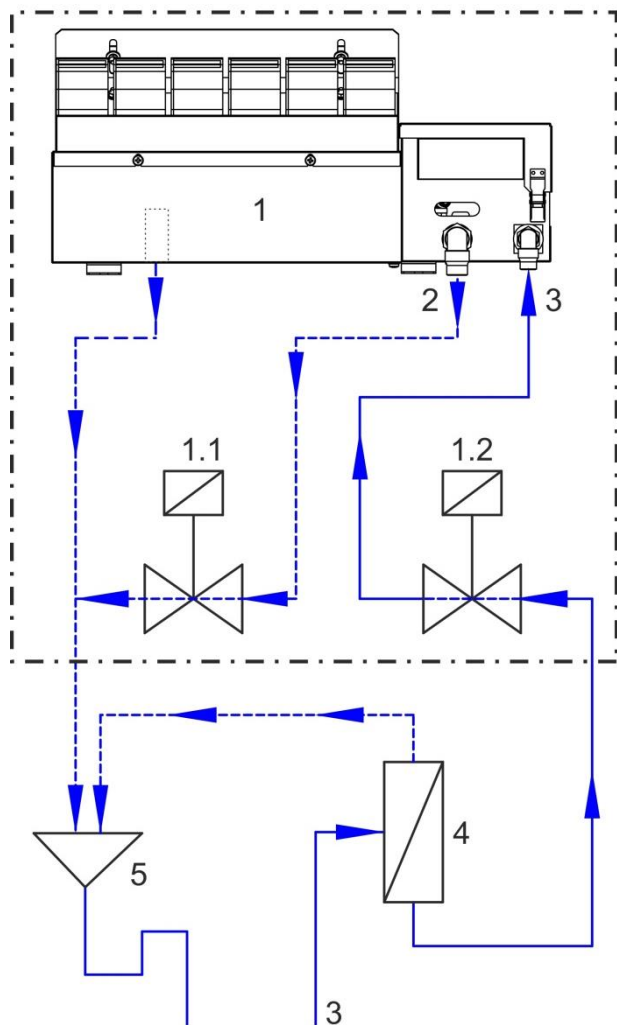

Fig. 32 - AquaDrain plus - diagram

13.2 Features

13.2.1 Flushing of water supply line

The humidifier goes into flushing mode, which is carried out in two phases depending on the time, for the following events:

1. Initial start-up (operating voltage is present for the first time)
2. Operating voltage is applied again (after each interruption of operation voltage)
3. After each humidifying pause which is longer than the AquaDrain plus cycle

The first phase includes the actual flushing process. The solenoid valves for supply and drain open at the same time for 120 seconds. The water supply pipes and/or tubes are rinsed. This ensures that the FIRST water present in the supply line (possibly hygienically questionable) is not nebulized as it is drained directly without filling up the fluid tank. The flushing volume depends on the pressure of the demineralised water (Fig. 37) and the flush time (Tab. 12-1).

In the second phase the solenoid valve supply is close. The solenoid valve drain remains open for 3, 4 or 5 Min. (Tab. 12-1 „AquaDrain Duration“) to ensure that the water that might still be inside the fluid tank is drained.

If a humidification request is made after the second phase, the humidifier will go into normal operation. At the same time, the solenoid valve supply opens and the solenoid valve drain closes. The fluid tank is filled up to maximum level. Humidification starts when there is a humidification request.

The filling time for the fluid tank of the humidifier is determined by the pressure of the demineralised water.

If no humidification request follows after the second phase, the humidifier will go into standby mode until a humidification request is carried out.

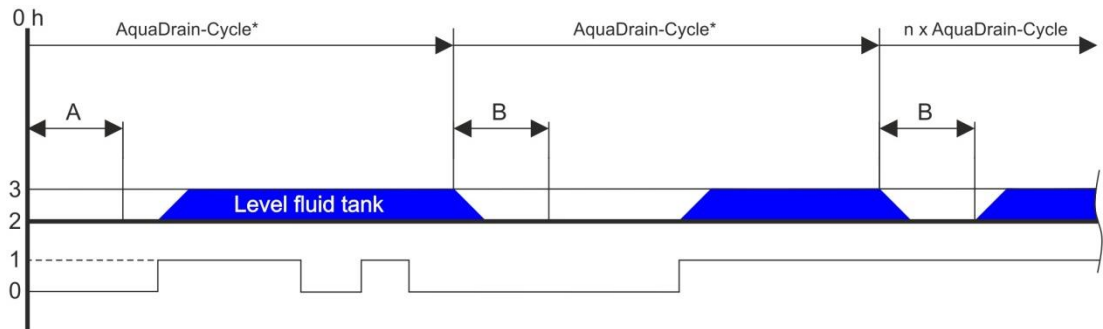



Fig. 33 - Example for commissioning and restart

Definitions

*) possible AquaDrain plus-Cycles: 10 Min., 30 Min, 1.5 h, 3 h, 6 h, 12 h, 24 h and 48 h (default 12 h, may be changed in the factory upon request)

- 0) Humidity request OFF
 - 1) Humidity request ON
 - 2) Fluid tank empty
 - 3) Fluid tank full
-
- A) Flushing of water supply line
 - B) Drainage of fluid tank

	<p>Any humidification request made during the AquaDrain plus duration will be ignored.</p>
---	--

13.2.2 Drainage of fluid tank

The NKBD is drained every 12 hours, if humidification took place in the last AquaDrain plus cycle and in case of any power interruption in the AquaDrain plus cycle (operating voltage is no longer present).

	<p>Any humidification request made during the drainage process will be ignored.</p>
---	---

If no humidification is requested, the humidifier is in standby mode.

If the fluid tub is still full, it will be automatically emptied after the adjustable "Inactivity Drain Timeout", Tab. 12-1. For optional factory settings, see chapter 12.1.4.

If the system is drained, the fluid tank will only be refilled, when a humidification request was made.

Time of AquaDrain Duration see Tab. 12-1.

The filling time for the fluid tank of the NKBD is determined by the pressure of the demineralised water and the NKBD-Type.

The fluid tank will stay dry, if there is no humidification request.

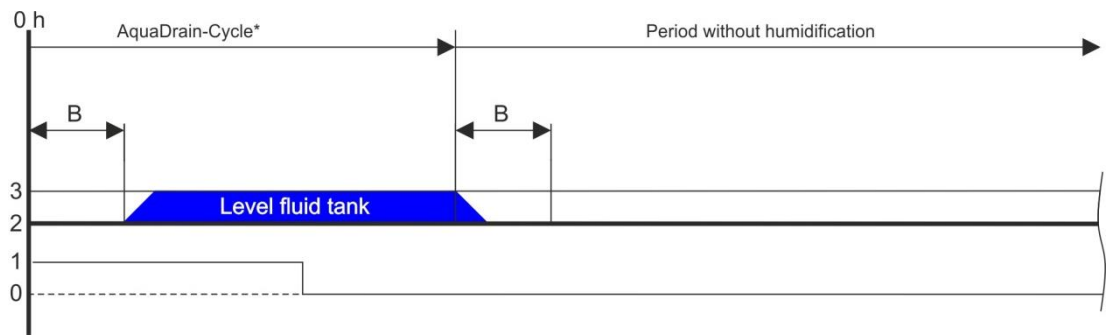

Fig. 34 - Period without humidification

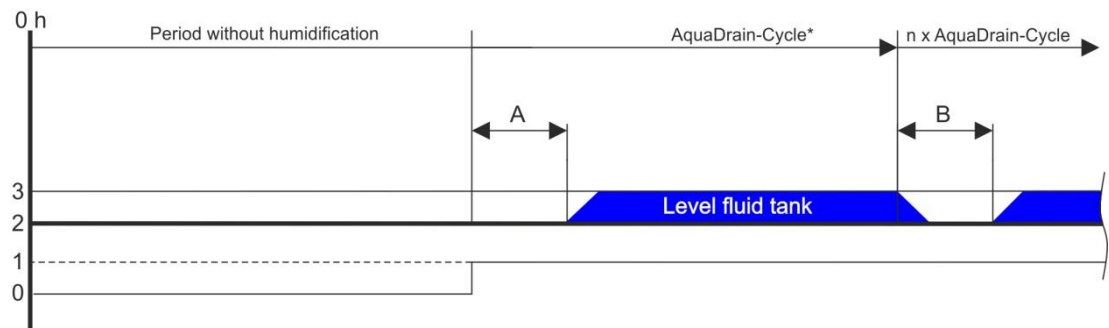

Fig. 35 - New humidification request

- A) Flushing of water supply line
- B) Drainage of fluid tank

13.3 AquaDrain plus diagrams

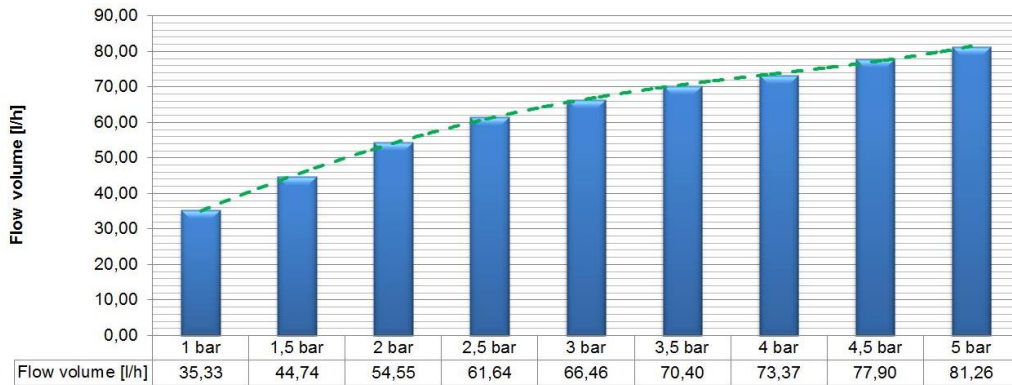

Fig. 36 - Flow volume solenoid valve supply ND 1.2 mm depending on water pressure

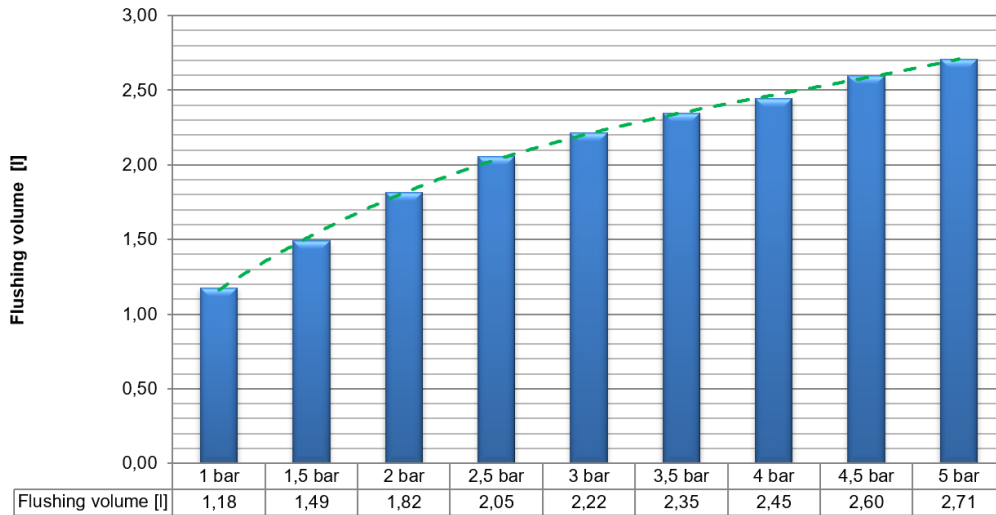

Fig. 37 - Flushing volume in litres at 120 sec flushing time depending on water pressure

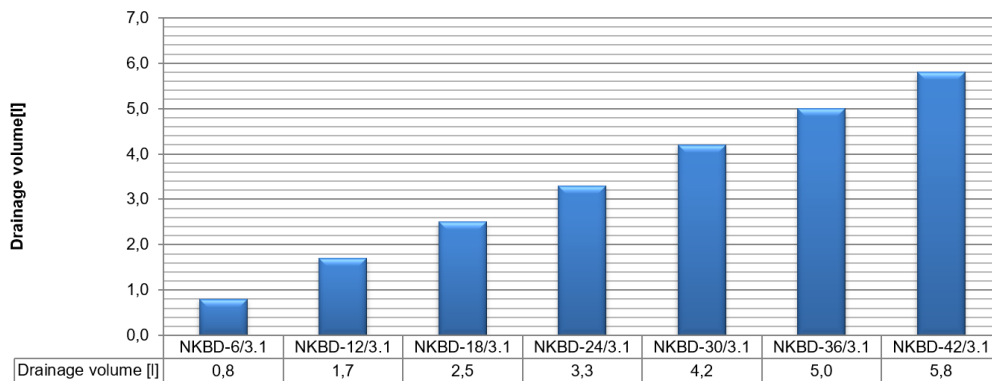



Fig. 38 - Drainage volume - fluid tank NKBD.../3.1

14. Dimensioning of cable cross section

The ohmic resistance between transformer and humidifier through the power cable produces a loss in voltage and consequently a drop in humidifier output.

	<p>The physical distance and the length of cable between the transformer and the humidifier should therefore be kept to a minimum!</p>
---	--

The voltage drop caused by ohmic resistance may be reduced by using a cable of large cross section and compensated for by the 53 V secondary connection at the transformer. The graphs Fig. 39- Fig. 45 show the ohmic loss for each humidifier depending on the cable length.

Using the 53 V transformer secondary voltage results in an overvoltage of 5 V (~ 10 % of 48 V) which may be consumed by the ohmic resistance of the cable. The correct cross-section of the cable will always be that which comes closest to the 5V mark for the voltage loss.

On account of the negligible power consumption of the humidifiers, the open-circuit voltage on the other hand is almost equal to the voltage at the transformer. To prevent damage to the humidifier electronics, the open circuit may **not exceed 54 V**.

Installation costs will be kept to a minimum if the graphs are correctly used.

	<p>The dimensions of the transformer is determined not only by the electrical power consumption of the humidifier NKBD but also on the power consumption of the cable feed (ohmic resistance)!</p>
---	--

The conductor resistance of fine-stranded:	1.5 mm ²	=	13.30 Ω/km
	2.5 mm ²	=	7.98 Ω/km
	4.0 mm ²	=	4.95 Ω/km
	6.0 mm ²	=	3.30 Ω/km
	10 mm ²	=	1.91 Ω/km
	16 mm ²	=	1.21 Ω/km
	25 mm ²	=	0.78 Ω/km

(extract from VDE 0295 and IEC 60228 for bare wires, class 5)

Conductor resistances refer to single-stranded conductors. They must therefore be multiplied by 2 for two-stranded conductors (N+L1).

In addition, the load capability of insulated leads (current density) should be taken into account. VDE 0100 Part 430 and Part 523).

	<p>The use of shielded Lines (e.g., LiYCY) recommended for the power supply 48V-AC, as well as the signal and control lines,</p>
---	--

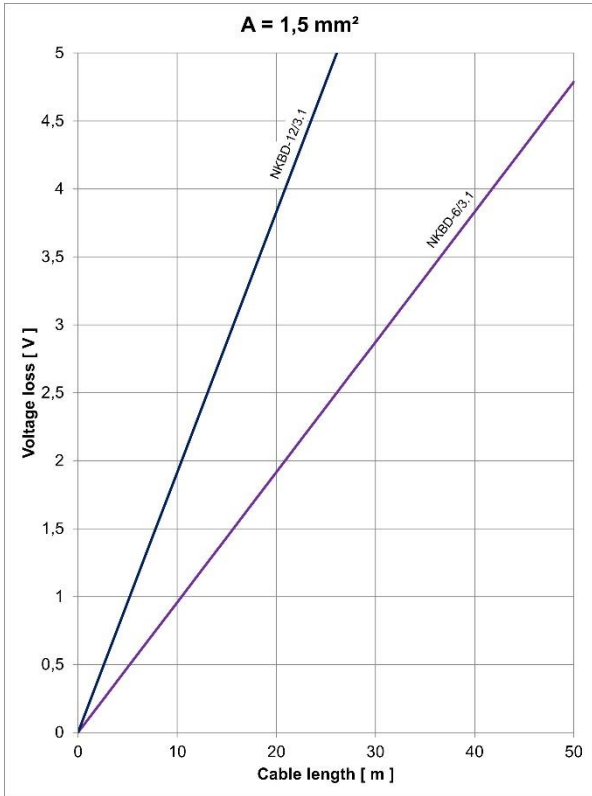

Fig. 39 - Voltage loss at A = 1.5 mm²

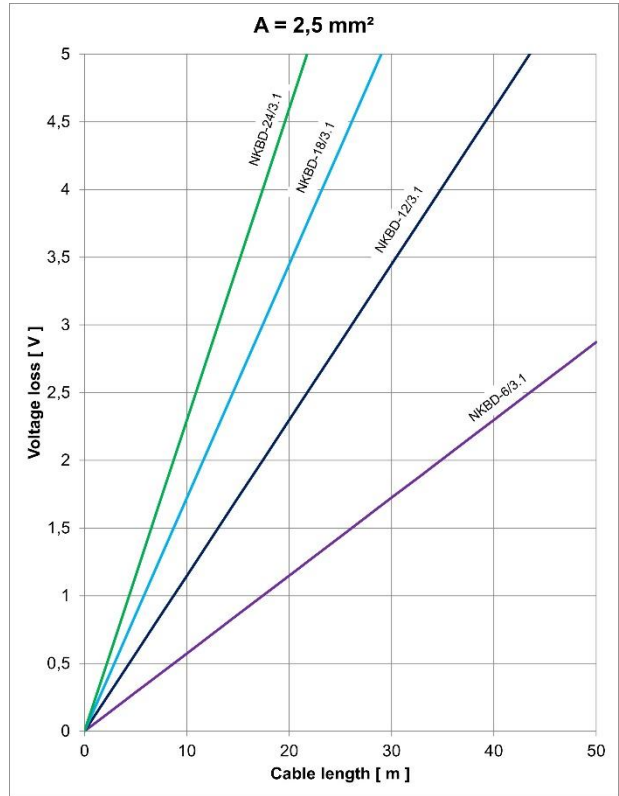

Fig. 40 - Voltage loss at A = 2.5 mm²

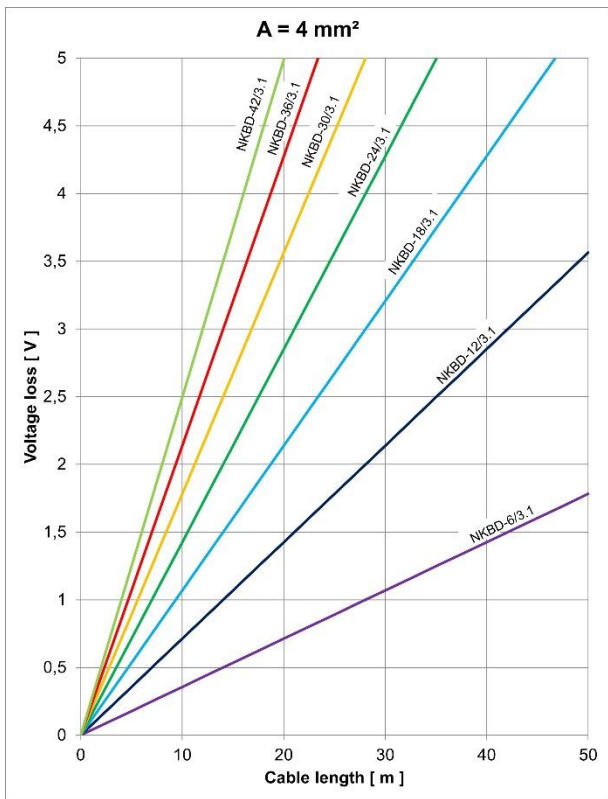

Fig. 41 - Voltage loss at A = 4 mm²

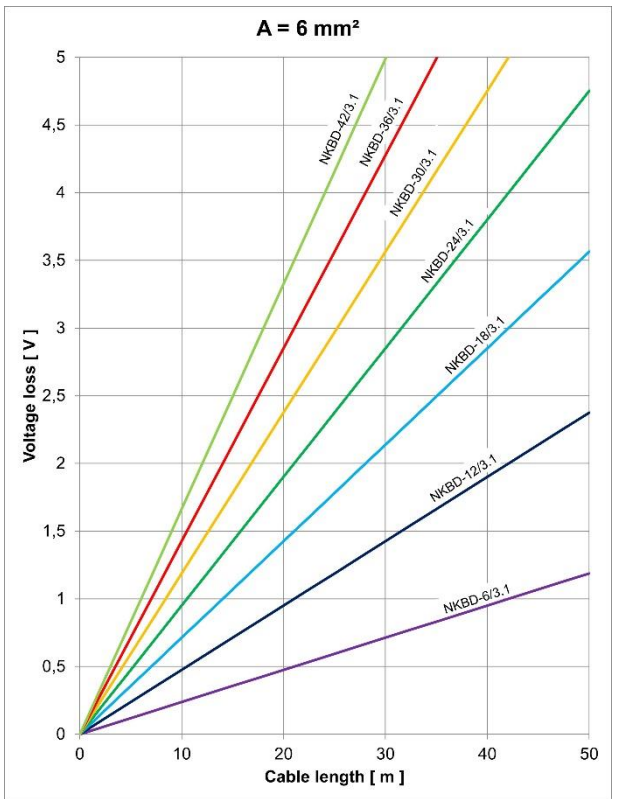

Fig. 42 - Voltage loss at A = 6 mm²

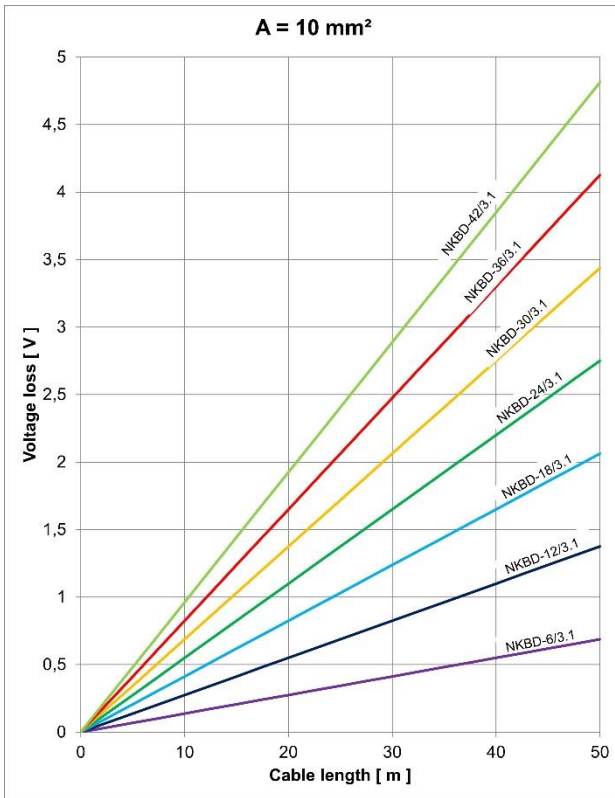

Fig. 43 - Voltage loss at A = 16 mm²

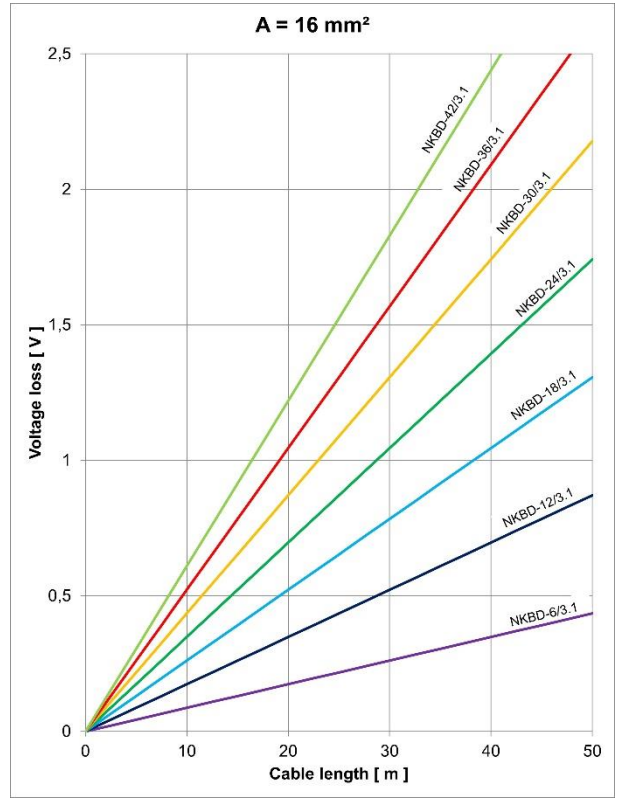

Fig. 44 - Voltage loss at A = 10 mm²

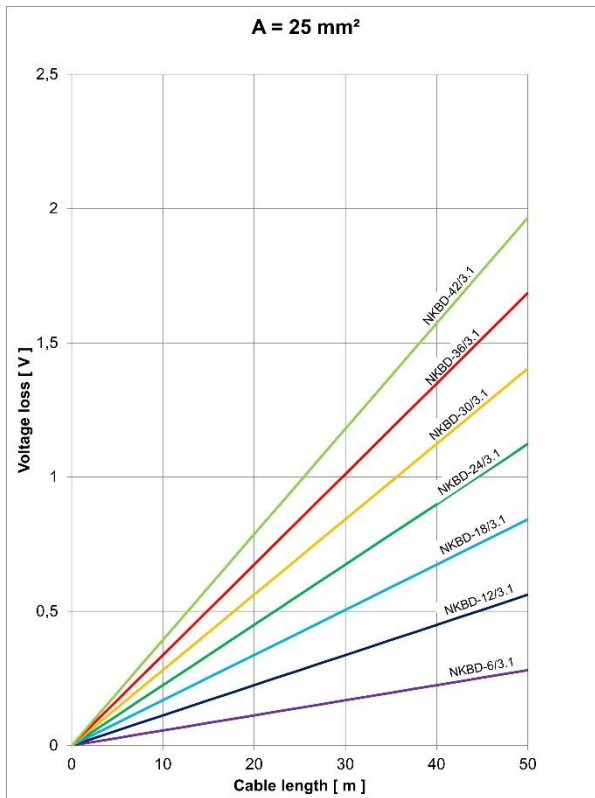

Fig. 45 - Voltage loss at A = 25 mm²

15. Commissioning

Before commissioning the NKBD, check once again that all installation and wiring work has been carried out correctly and fully completed. In particular, the water and power supply connections must be in proper order and comply with the relevant safety regulations.

15.1 Manual functions:

- *Release of permeate inlet into the device*
- *Release of 230 V / 50 Hz to the transformer and switch on transformer*
- *The TARGET humidity at the continuous control must be higher than the ACTUAL humidity*

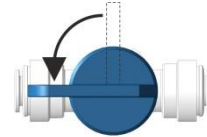

Fig. 46 - Stop cock



Fig. 47 - Circuit breaker



Fig. 48 - Continuous controller in the control cabinet

15.2 Automatic functions:

- *Flushing of water supply line:*

The solenoid valve supply of the humidifier opens. The solenoid valve drain is open. The water supply line is flushed without the fluid tank of the NKBD being filled.

After that, the solenoid valve supply closes again. The solenoid valve drain stays open for 3, 4 or 5 minutes (Tab. 12-1 "AquaDrain Duration").

- *Filling the fluid tank:*

The Solenoid valve drain closes. The Solenoid valve supply opens. The fluid tank of the NBKD is filled. The water level is automatically controlled within narrow tolerances.



The fluid tank may only be filled if a humidification request has been made. Otherwise the fluid tank of the NKBD will remain dry.

- *Humidification:*

Once the maximum water level is reached and the humidification request is still present, humidification will start.

15.3 Make applied settings:

- Set target humidity

Commissioning of the NKBD is completed.

16. Technical Data

Tab. 16-1 - Technical Specifications

Specifications		NKBD-6 /3.1	NKBD-12 /3.1	NKBD-18 /3.1	NKBD-24 /3.1	NKBD-30 /3.1	NKBD-36 /3.1	NKBD-42 /3.1
max. Humidifying capacity *	kg/h	3.6	7.2	10.8	14.4	18.0	21.6	25.2
Transducer	Unit	6	12	18	24	30	36	42
Power supply	V / 50 Hz	48	48	48	48	48	48	48
Power consumption	VA / 50 Hz	185	375	555	735	915	1095	1275
	VA / 60 Hz	220	448	660	875	1089	1303	1518
Transformer **	ST	500	500	1000	1000	1600	1600	1600

* Humidifying capacity is dependent on the quantitative air flow rate through the humidifier (air velocity in the duct), on the uniformity of flow over the entire fluid tank length, on the level of supply voltage under load (nominal 48 V), on the water temperature and on the cleanliness of the fluid tank and the ultrasonic transducers (regular care).

** The power output of the transformers stated is optimised for the NKBD types. Their power reserves are sufficient to bear the power consumption of a correctly laid supply cable with short distance between humidifier and transformer. Nevertheless, it is advisable to check transformer selection mathematically according to local conditions.

Tab. 16-2 - Safety devices

Safety devices	Description
Dry-running protection with functional redundancy	If the water level falls below the minimum level in the fluid tank, the humidification switches off. For this purpose, both level switches are monitored separately.
Overheating protection	The humidifier stops humidifying at water temperatures > 60 °C.
Overflow protection	If the humidifier fluid tank is overfilled, the excess water is drained off to the outside through the overflow.
Disconnect protection	There are no defects in the event of electrical interruptions between the oscillator board and the transducer.
Monitoring	Monitoring of important system components with integrated problem solver routines.
Protection against power surges	The control board is protected by its own fuse. A varistor in the input of the power supply protects against power surges.

Tab. 16-3 - Operation conditions

Operation conditions	Parameter
Maximum air humidity	< 90 % relative humidity – no condensation!
Air temperature	5 - 45 °C
Demineralised water pressure	1 - 4 bar
Demineralised water quality	fully demineralised
Demineralised water conductivity	5 - 20 µS/cm

17. Device dimensions / weights

Tab. 17-1 - Dimensions and weights

NKBD.../3.1											
Type	Weight	Dimensions						Point mounting			
		width	T	depth		height		P1	P2	P3	P4
		B		T1	T2	H1 min.	H1 max.				
kg	mm	mm	mm	mm	mm	mm	mm	mm	mm	mm	
NKBD-6/3.1	6.0	286	198	261	288	201	241	124	-	-	231
NKBD-12/3.1	7.7	436	198	261	288	201	241	274	-	-	231
NKBD-18/3.1	9.5	586	198	261	288	201	241	394	-	-	231
NKBD-24/3.1	11.7	736	198	261	288	201	241	544	-	-	231
NKBD-30/3.1	13.7	886	198	261	288	201	241	694	312	382	231
NKBD-36/3.1	15.2	1036	198	261	288	201	241	844	387	457	231
NKBD-42/3.1	17.2	1186	198	261	288	201	241	994	562	532	231

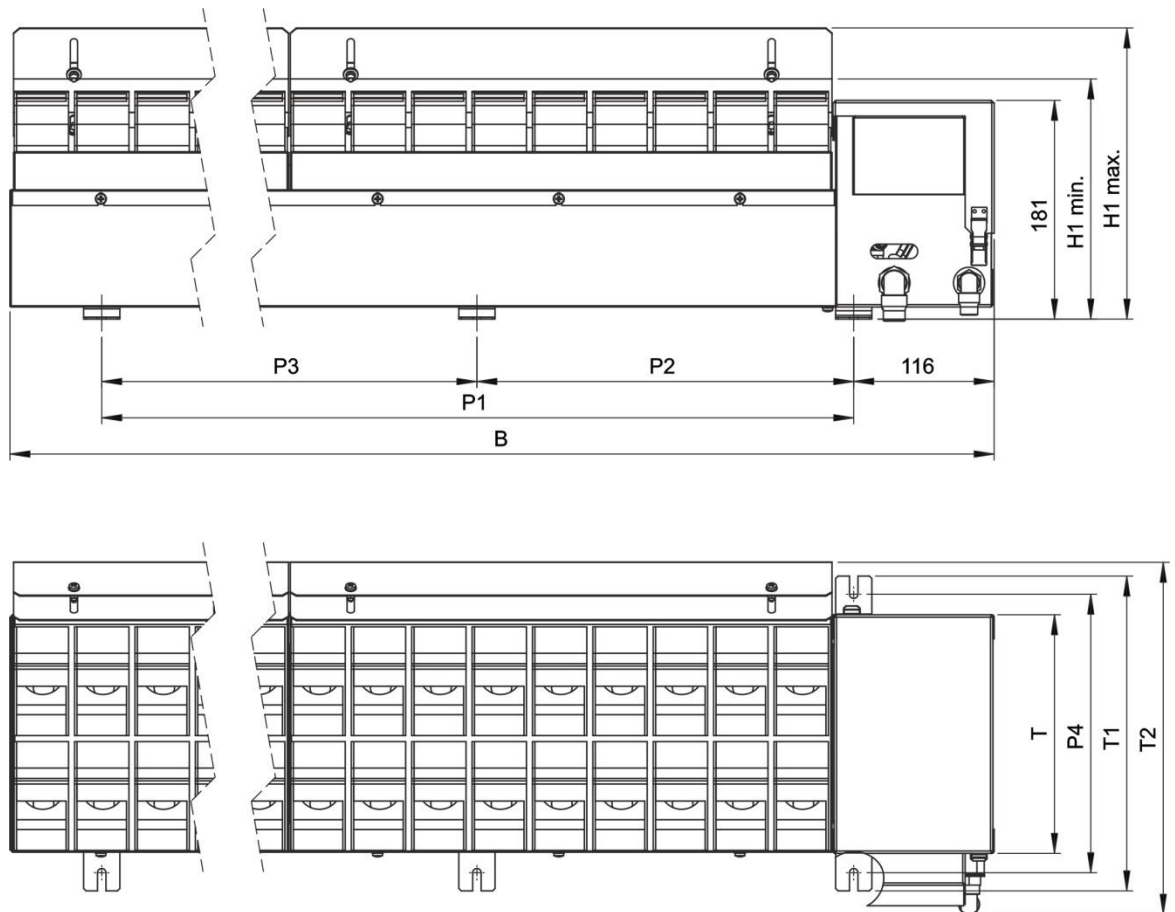

Fig. 49 - Technical drawing NKBD.../3.1 dimensions

18. Circuit diagrams

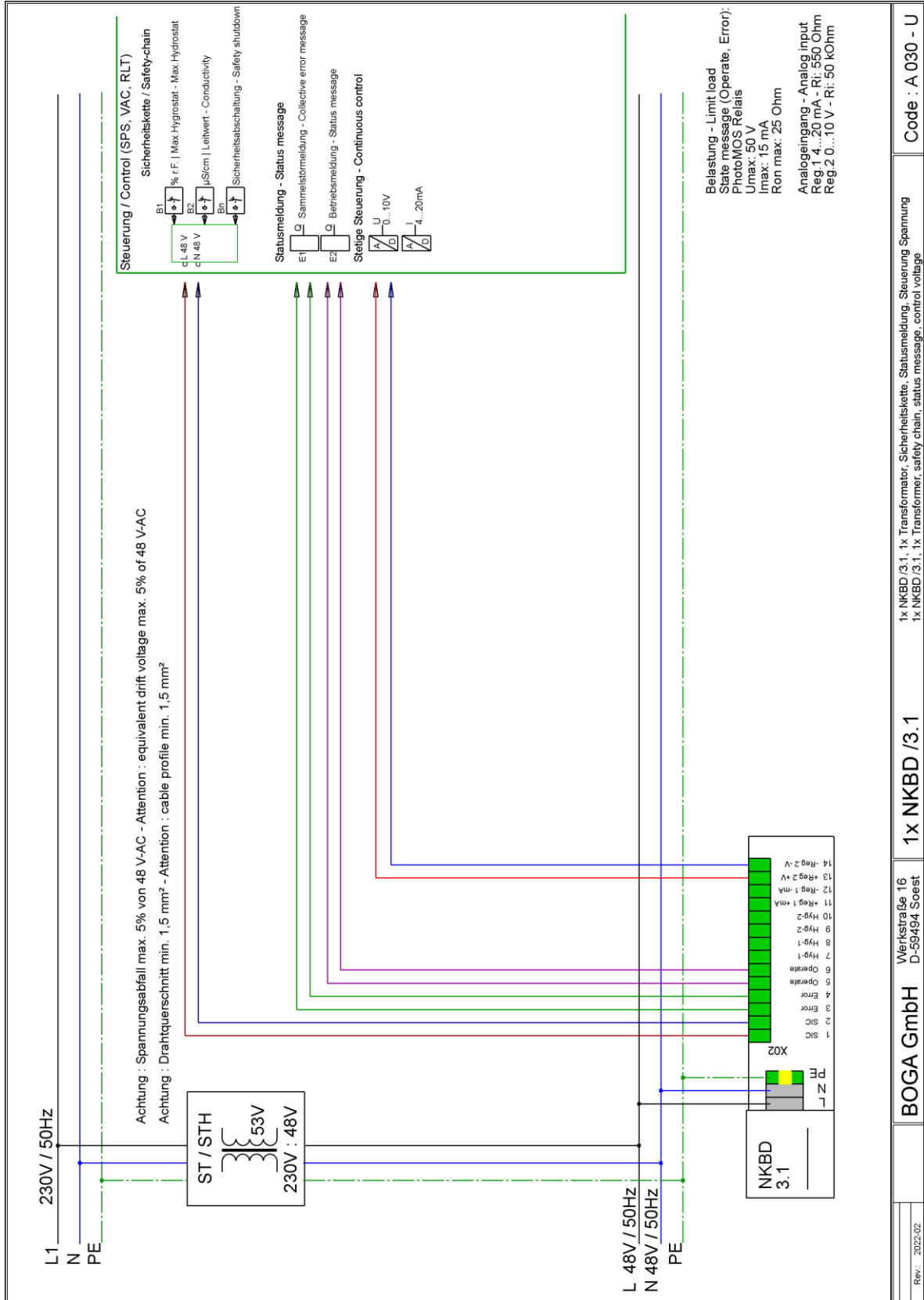

Fig. 50 - 1x NKBD-6...42/3.1, 1x transformer, safety chain, status message, control voltage

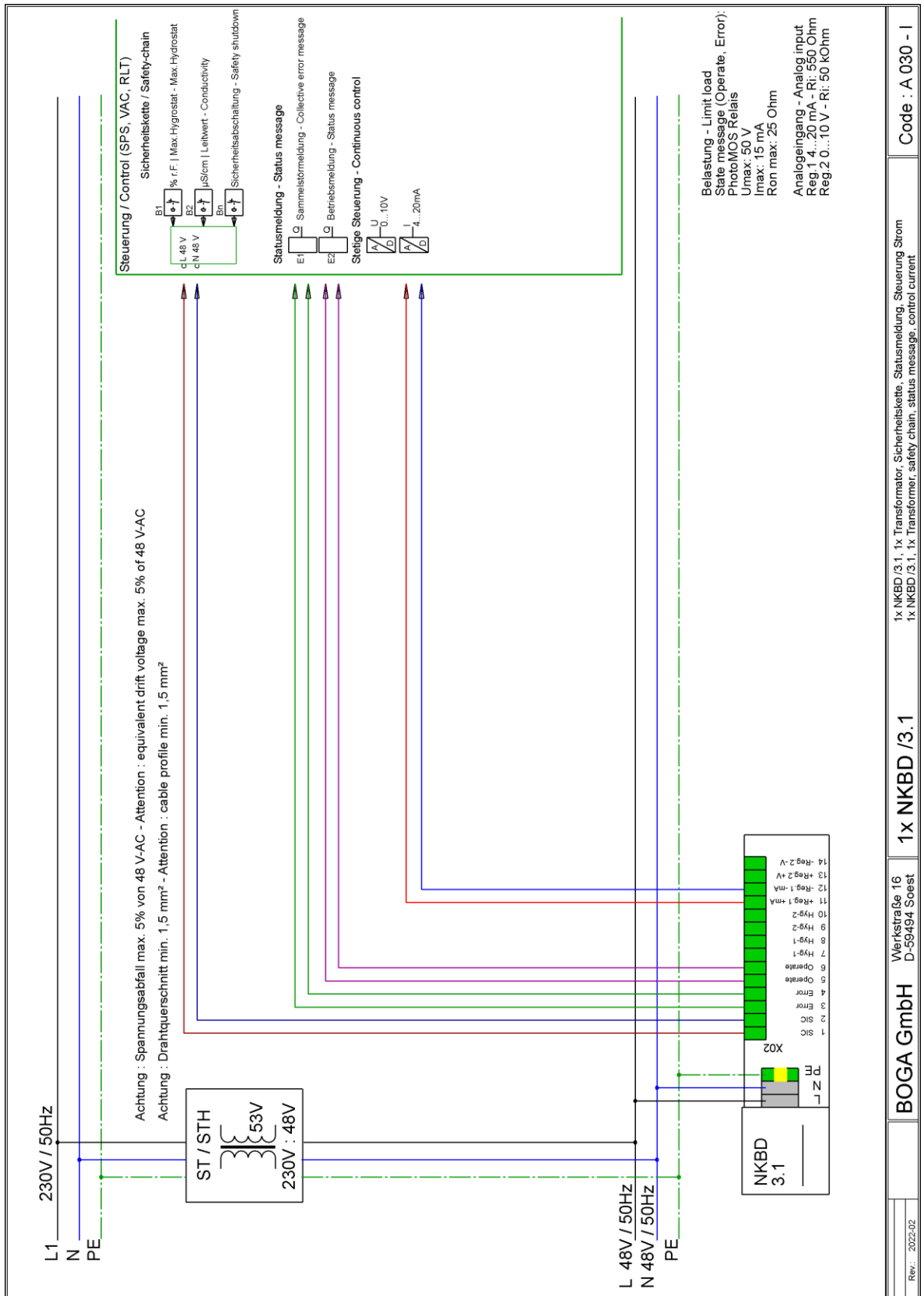

Fig. 51 - 1x NKBD-6...42/3.1, 1x transformer, safety chain, status message, control current

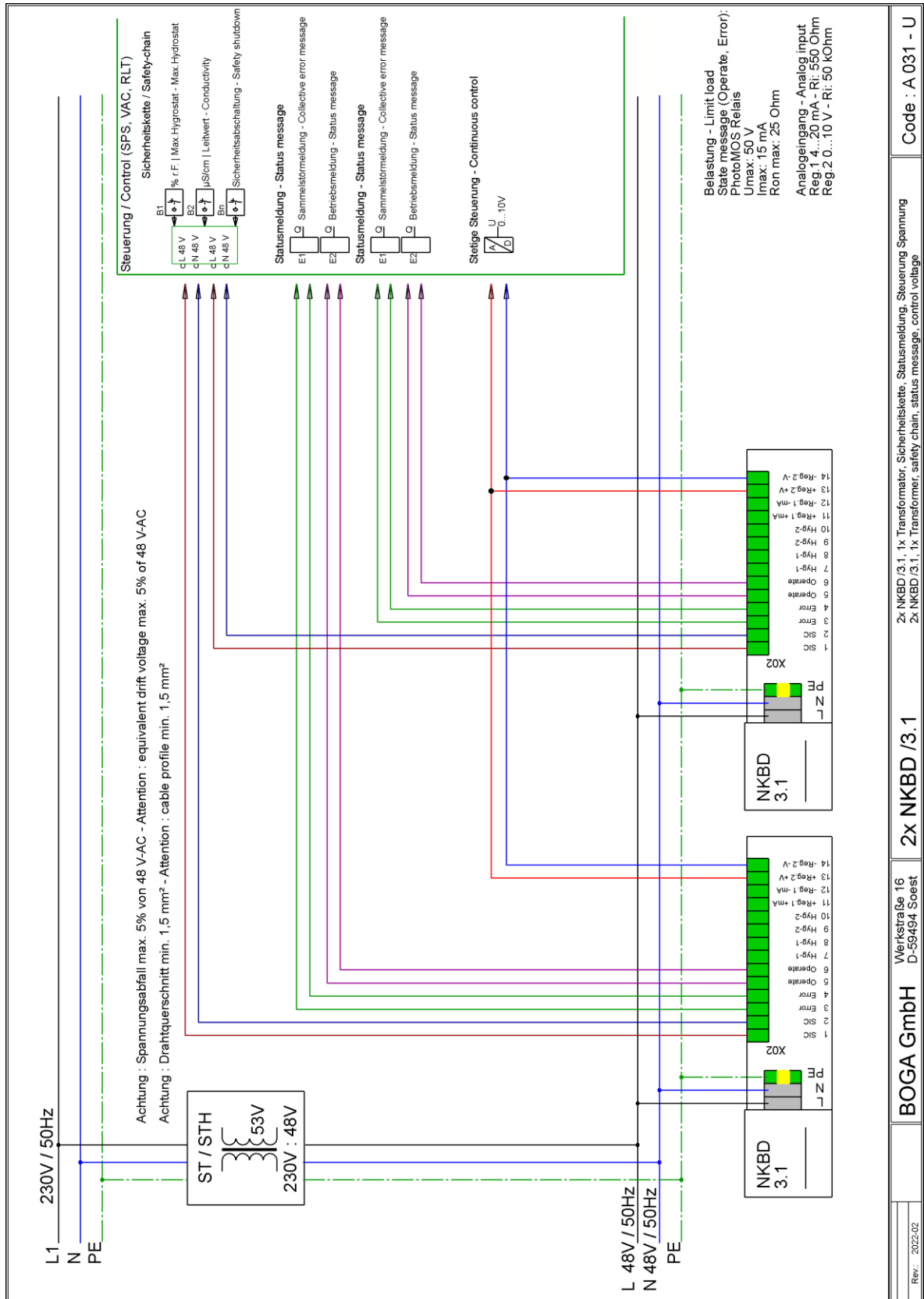

Fig. 52 - 2x NKBD-6...42/3.1, 1x transformer, safety chain, status message, control voltage

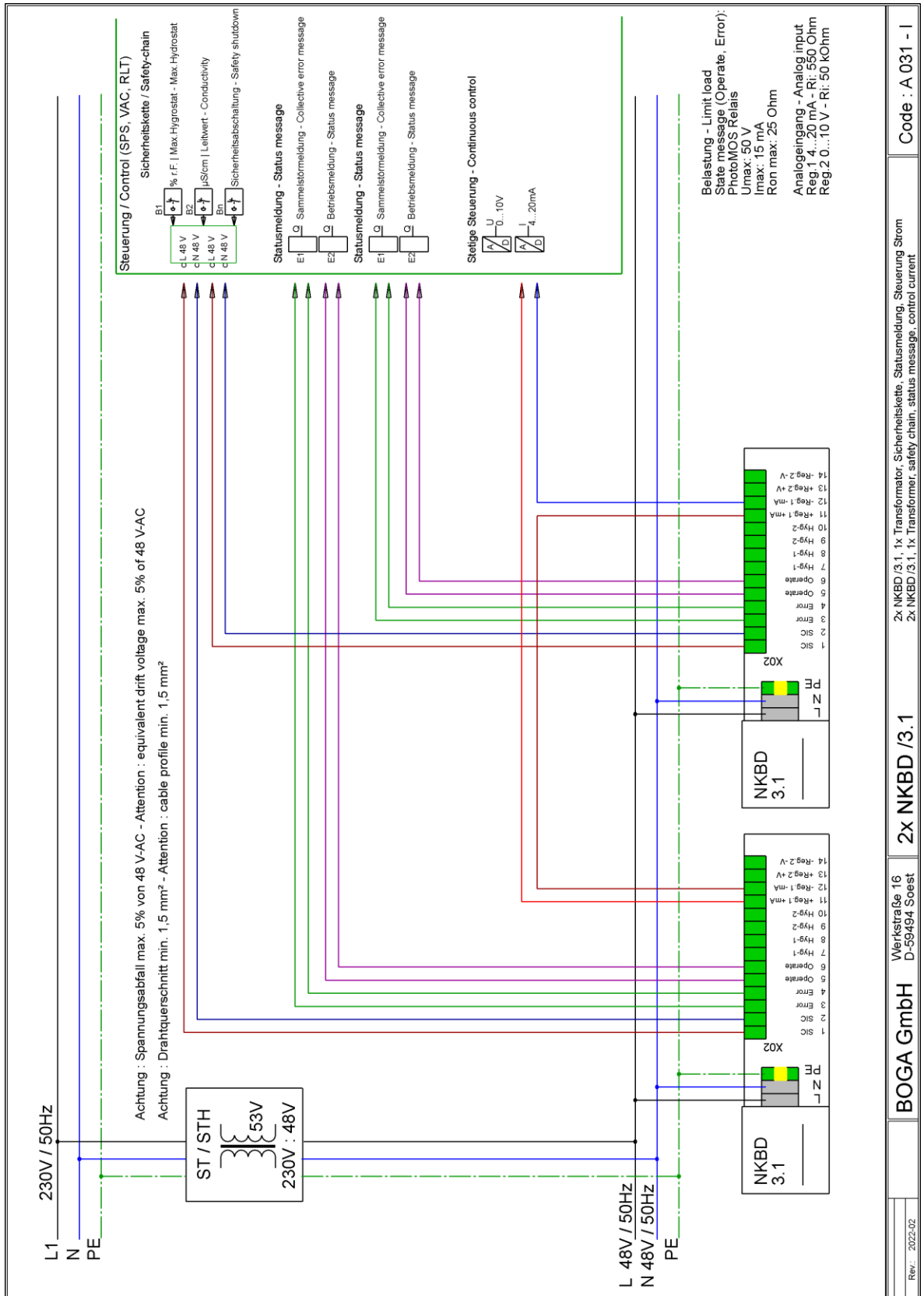

Fig. 53 - 2x NKBD-6...42/3.1, 1x transformer, safety chain, status message, control current

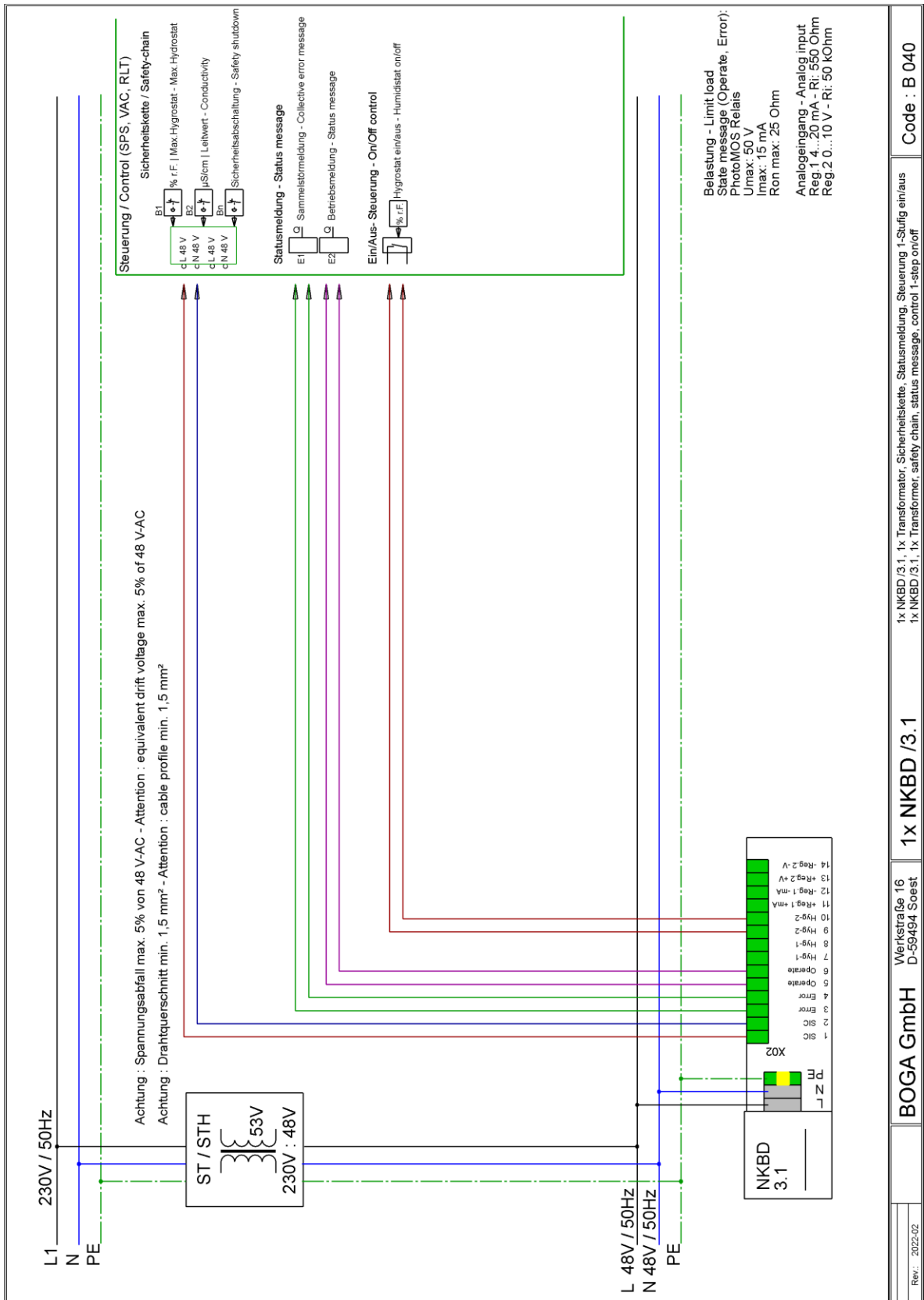

Fig. 54 - 1x NKBD-6...42/3.1, 1x transformer, safety chain, status message, control 1-step on/off

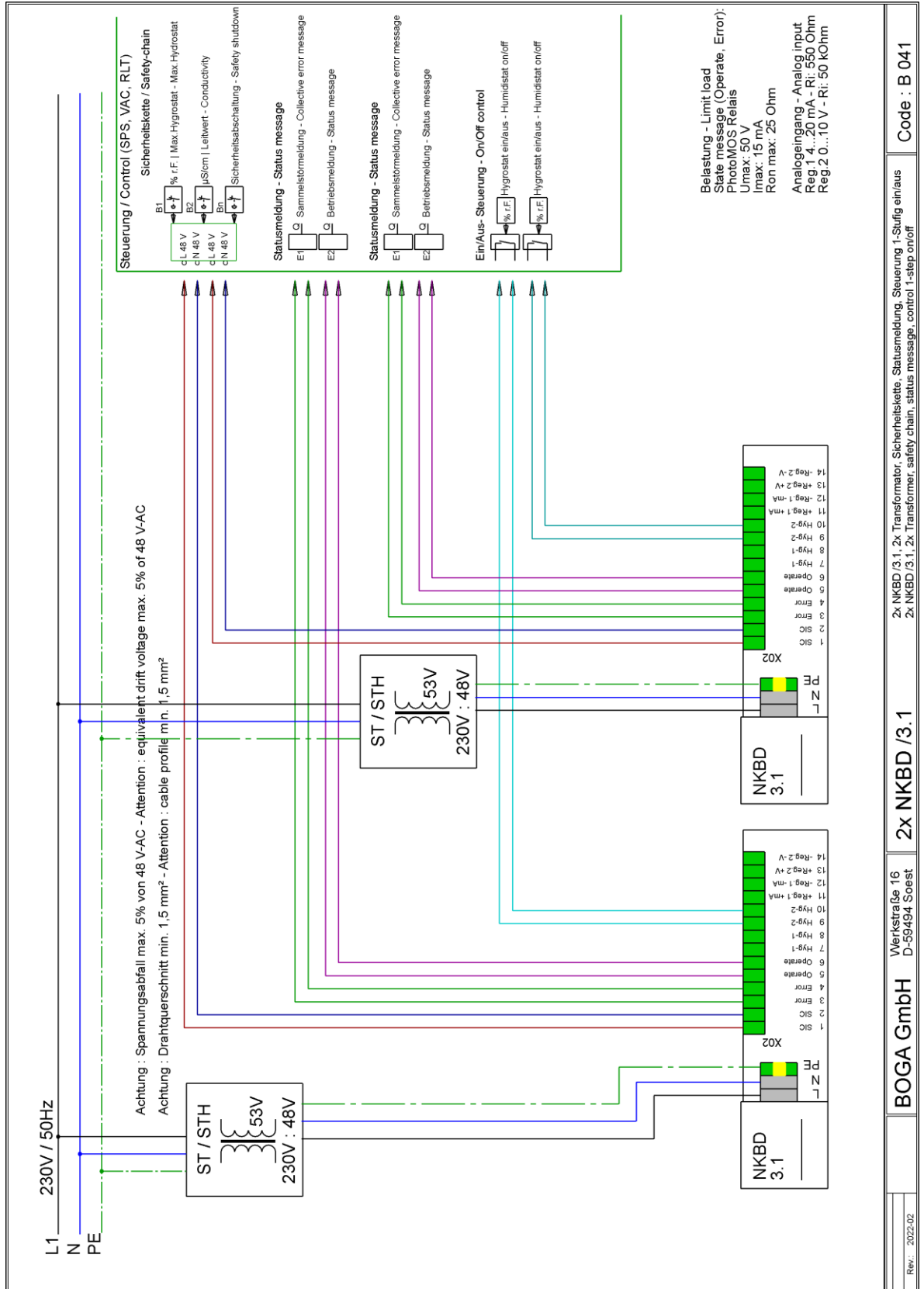

Fig. 55 - 2x NKBD-6...42/3.1, 2x transformer, safety chain, status message, control 1-step on/off

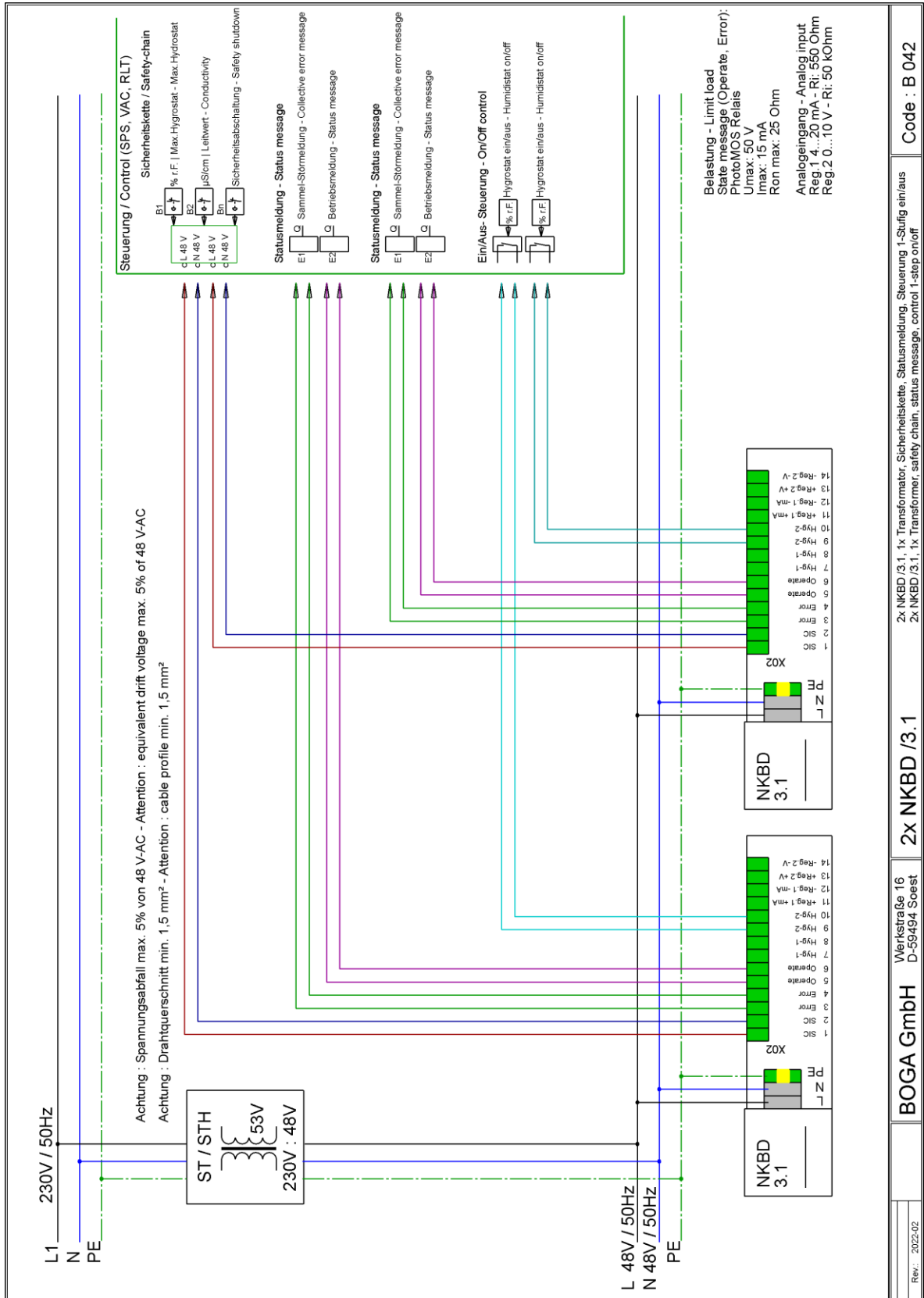

Fig. 56 - 2x NKBD-6...42/3.1, 1x transformer, safety chain, status message, control 1-step on/off

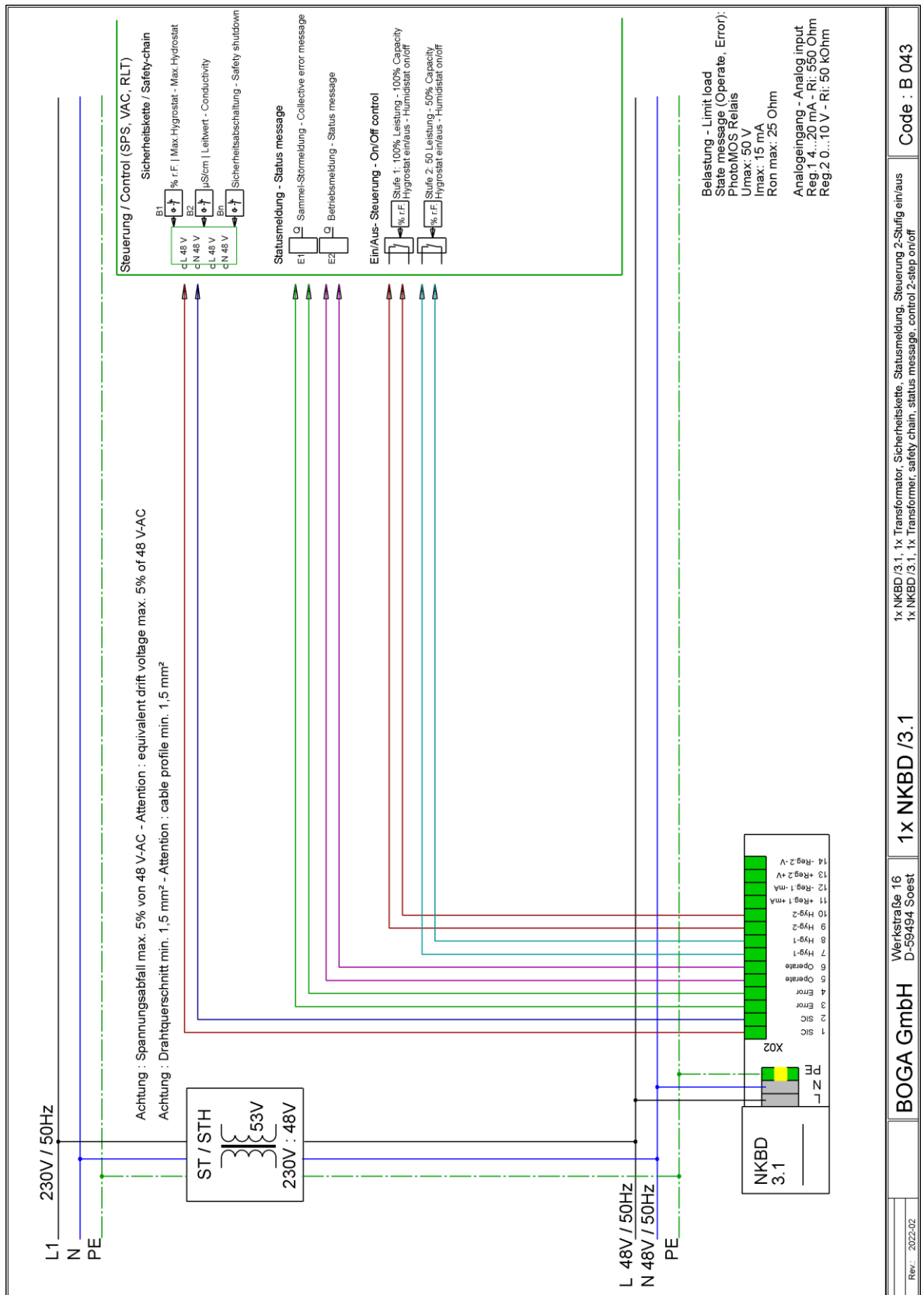

Fig. 57 - 1x NKBD-6...42/3.1, 1x transformer, safety chain, status message, control 2-step on/off

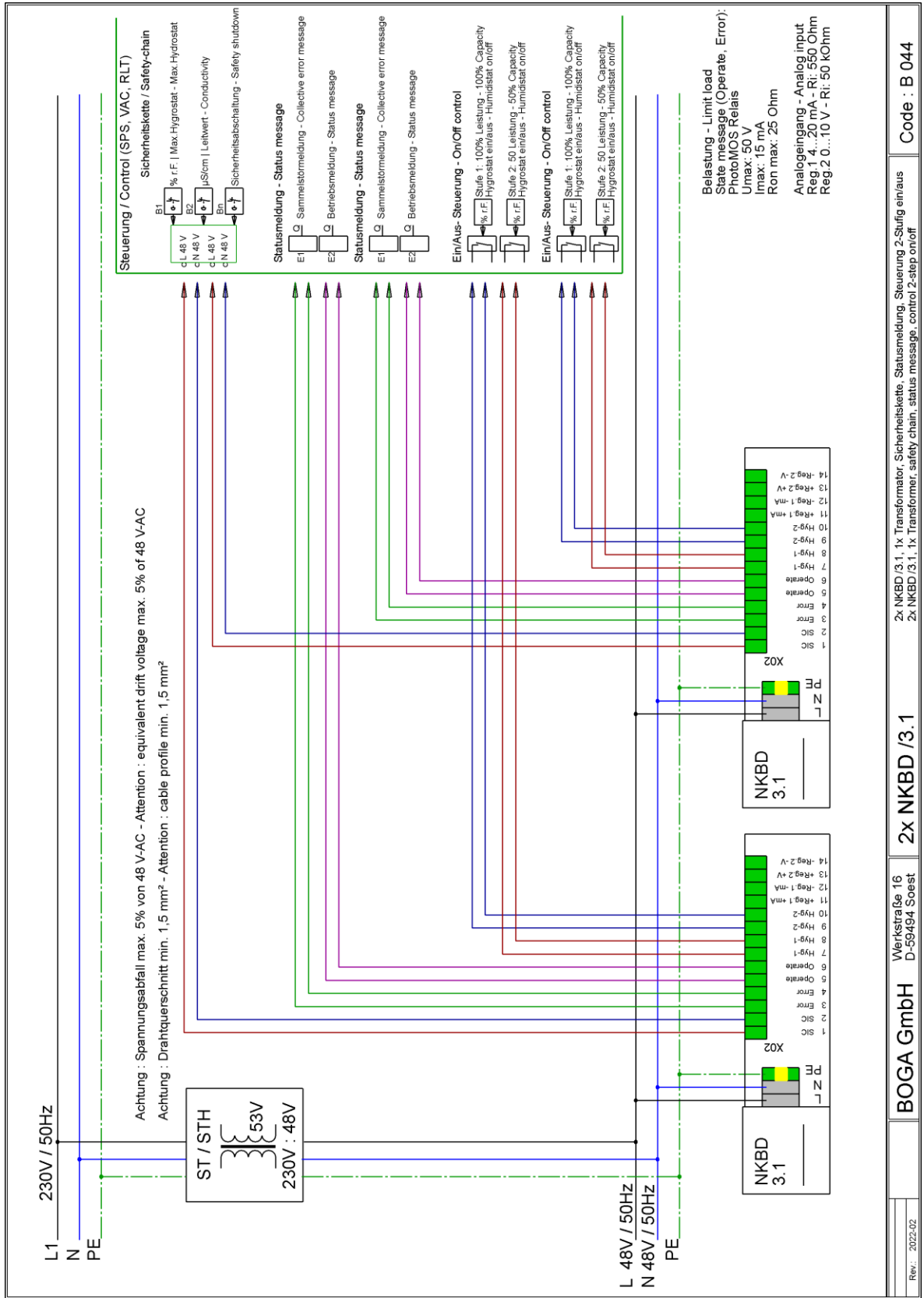

Fig. 58 - 2x NKBD-6...42/3.1, 1x transformer, safety chain, status message, control 2-step on/off

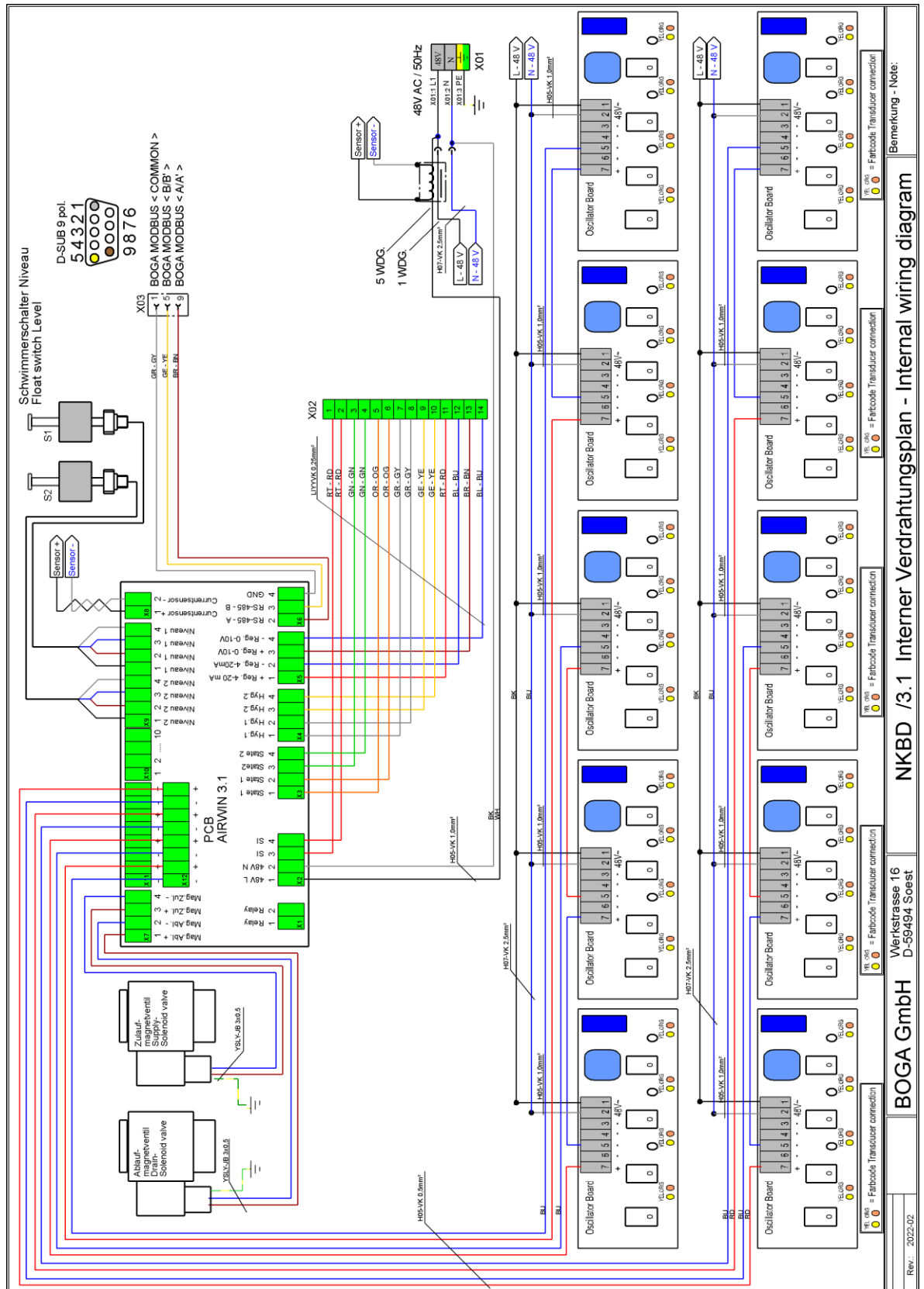

Fig. 59 - Internal wiring NKBD-6...42/3.1

19. Care

It is essential that the humidifier is easy to inspect and easily accessible on site.



Good accessibility and exchangeability of the humidifier save costs!

Prior to opening the humidifier, it must be disconnected from the electricity and water supply.

Then remove the duct support. In case of pollution, the fluid tank of the humidifier must be cleaned by using a clean, medium hard brush and clean water. The transducers must be wiped clean with a soft, scratch-free cloth. Incrustations or solid deposits on the transducers must be carefully removed. For that purpose, it is recommended to use 20 % formic acid.



Deposits are a direct consequence of inadequate water quality!

The care intervals depend on the respective degree of contamination of the humidifier. It depends directly on the cleanliness of the intake air and the feed water quality. It may be necessary to perform care at shorter intervals.

The performance of the ultrasonic transducers decreases with actual operating hours. The life time of the ultrasonic transducers will be shortened by unfavourable operating conditions e.g. water and air pollution or overvoltage.



Care and cleaning tasks	
1. Checks	
<p>Check the air duct, the fluid tank and the transducers for contamination. → Clean them, if necessary!</p>	<p>Initially, a check has to be carried out after 1 week. Depending on the degree of contamination of the fluid tank and the transducers the cleaning intervals must be adjusted.</p>
	<p>If pollution is found during the check, cleaning must be performed.</p>
2. Care and cleaning	
<p>- Fluid tank - Transducers</p>	<p>Slime in the fluid tank is a sign of the presence of micro-organisms! Cause: Air and/or water</p> <p>Incrustations are mineral deposits! Cause: Water</p>
Measures	<ul style="list-style-type: none"> • Check and clean the air duct, if required! • Check reverse osmosis system! • Adjust cleaning intervals!
	<p>Even without visible pollution, cleaning must be done at least every 12 months.</p>

20. Standards

20.1 EC declaration of conformity according to Machinery directive 2006/42/EC, Annex II 1.A

The resident authorised representative in the community

BOGA GmbH
Werkstraße 16
D-59494 Soest

hereby declares that the following product

Product designation: Duct humidifier
Make: AIRWIN
Series/type designation: NKBD-6/3.1,
NKBD-12/3.1,
NKBD-18/3.1,
NKBD-24/3.1,
NKBD-30/3.1,
NKBD-36/3.1,
NKBD-42/3.1,

fulfills all the relevant provisions of the directive specified above and the additionally applied directives (in the following) - including the changes which applied at the time of the declaration.

The following additional EU directives have been applied:

- EMC Directive 2014/30/EU
- RoHS directive 2011/65/EU

The series complies with the safety regulations of VDE 0100 and was tested in accordance with VDE 701 part 1.

20.2 WEEE

The humidifier is WEEE-registered.

20.3 Imprint - Copyright

Imprint

BOGA GmbH
Gesellschaft für moderne Gerätetechnik
Werkstraße 16
D-59494 Soest
Phone : +49 2921 96943-0
Fax : +49 2921 96943-29
E-mail : info@boga.de
Website : www.boga.de

Copyright

The copyright and all other rights of use for the documents belong to BOGA GmbH. The documents may not be copied, distributed, publicly displayed, edited or otherwise transformed without the written consent of BOGA GmbH.



21. List of figures

Fig. 1 - Schematic sketch of piezo-effect	7
Fig. 2 - Schematic sketch aerosol production	8
Fig. 3 - Device overview NKBD-30/3.1	10
Fig. 4 - Schematic illustration of NKBD-12/3.1 air humidification system	11
Fig. 5 - Side view into an air duct with one NKBD.....	13
Fig. 6 - View into an air duct in direction of air flow, two NKBD mounted one above the other.....	13
Fig. 7 - Side view into an air duct with three NKBD	14
Fig. 8 - View into an air duct in direction of air flow, three NKBD mounted above each other	14
Fig. 9 - Side view NKBD in the air duct	15
Fig. 10 - Top view NKBD in the air duct	15
Fig. 11 - Set folded sheet	16
Fig. 12 - Set extension	16
Fig. 13 - Set closing sheet.....	16
Fig. 14 - Rotate duct support.....	17
Fig. 15 - Schematic diagram of hydraulic conditions.....	18
Fig. 16 - Establishing the connection	19
Fig. 17 - Insert tube	19
Fig. 18 - Check connection.....	19
Fig. 19 - Detaching the connection.....	19
Fig. 20 - Transformer with one secondary output	20
Fig. 21 - Transformer with multiple secondary outputs	20
Fig. 22 - Electrical connections	21
Fig. 23 - D-SUB socket.....	22
Fig. 24 - Safety chain.....	22
Fig. 25 - PhotoMOS Relais.....	22
Fig. 26 - Control board PCB AIRWIN 3.1 Input.....	24
Fig. 27 - Control board PCB AIRWIN 3.1 Outputs	25
Fig. 28 - State diagram	30
Fig. 29 - Control board PCB AIRWIN 3.1	31
Fig. 30 - Decoding LED-Display	32
Fig. 31 - Level switch S2	32
Fig. 32 - AquaDrain plus - diagram	34
Fig. 33 - Example for commissioning and restart.....	36
Fig. 34 - Period without humidification	37
Fig. 35 - New humidification request	37
Fig. 36 - Flow volume solenoid valve supply ND 1.2 mm depending on water pressure	38
Fig. 37 - Flushing volume in litres at 120 sec flushing time depending on water pressure.....	38
Fig. 38 - Drainage volume - fluid tank NKBD.../3.1.....	38
Fig. 39 - Voltage loss at A = 1.5 mm ²	40
Fig. 40 - Voltage loss at A = 2.5 mm ²	40
Fig. 41 - Voltage loss at A = 4 mm ²	40
Fig. 42 - Voltage loss at A = 6 mm ²	40
Fig. 43 - Voltage loss at A = 16 mm ²	41
Fig. 44 - Voltage loss at A = 10 mm ²	41
Fig. 45 - Voltage loss at A = 25 mm ²	41
Fig. 46 - Stop cock.....	42
Fig. 47 - Circuit breaker.....	42
Fig. 48 - Continuous controller in the control cabinet.....	42
Fig. 49 - Technical drawing NKBD.../3.1 dimensions	45
Fig. 50 - 1x NKBD-6...42/3.1, 1x transformer, safety chain, status message, control voltage	46
Fig. 51 - 1x NKBD-6...42/3.1, 1x transformer, safety chain, status message, control current	47
Fig. 52 - 2x NKBD-6...42/3.1, 1x transformer, safety chain, status message, control voltage	48
Fig. 53 - 2x NKBD-6...42/3.1, 1x transformer, safety chain, status message, control current	49
Fig. 54 - 1x NKBD-6...42/3.1, 1x transformer, safety chain, status message, control 1-step on/off	50
Fig. 55 - 2x NKBD-6...42/3.1, 2x transformer, safety chain, status message, control 1-step on/off	51
Fig. 56 - 2x NKBD-6...42/3.1, 1x transformer, safety chain, status message, control 1-step on/off	52
Fig. 57 - 1x NKBD-6...42/3.1, 1x transformer, safety chain, status message, control 2-step on/off	53
Fig. 58 - 2x NKBD-6...42/3.1, 1x transformer, safety chain, status message, control 2-step on/off	54
Fig. 59 - Internal wiring NKBD-6...42/3.1	55

List of tables

Tab. 11-1 - Assignment of power connection terminals	21
Tab. 11-2 - Assignment of control connection terminals	21
Tab. 11-3 - Assignment of D-SUB socket.....	22
Tab. 11-4 - Status messages operation / error.....	22
Tab. 11-5 - Thresholds analog input.....	23
Tab. 12-1 - Default settings PCB AIRWIN 3.1	27
Tab. 12-2 - Status messages - System States.....	31
Tab. 12-3 - Troubleshooting checklist	33
Tab. 16-1 - Technical Specifications	44
Tab. 16-2 - Safety devices.....	44
Tab. 16-3 - Operation conditions	44
Tab. 17-1 - Dimensions and weights	45